

~~CONFIDENTIAL~~

FM 31-20

DEPARTMENT OF THE ARMY FIELD MANUAL

U.S. ARMY SPECIAL FORCES GROUP (AIRBORNE) (U)

Classified by DA
Subject to GDS of EO 11652
Automatically Downgrade at Two
Year Intervals
Declassified on May 3, 1976.



DEPARTMENT OF THE ARMY

AUGUST 1955

~~CONFIDENTIAL~~

~~CONFIDENTIAL~~

**U.S. ARMY SPECIAL FORCES GROUP
(AIRBORNE) (U)**

	<i>Paragraphs</i>	<i>Page</i>
<hr/>		
PART ONE. SPECIAL FORCES GROUP ORGANIZATION AND MISSION		
CHAPTER 1. GENERAL.....	1-8	5
2. SPECIAL FORCES GROUP HEADQUARTERS AND STAFF		
Section I. The unit staff.....	9-14	11
II. The special staff	15-26	17
CHAPTER 3. SPECIAL FORCES AD- MINISTRATIVE UNITS.....	27-30	28
CHAPTER 4. SPECIAL FORCES OPER- TIONAL TEAMS.....	31-35	34
PART TWO. SPECIAL FORCES GROUP FUNCTIONS AND OP-ERATIONS		
CHAPTER 5. THE SPECIAL FORCES BASE		
Section I. Introduction.....	36-39	38
II. Command and staff structure	40,41	41
III. Base functions	42-46	42
CHAPTER 6. SPECIAL FORCES AD- MINISTRATION.....	47-51	45
7. SPECIAL FORCES IN- TELLIGENCE	52-54	49
8. SPECIAL FORCES TRAINING.....	55-57	51

*This manual supersedes FM 31-20, 1 February 1951.

~~CONFIDENTIAL~~

CHAPTER 9. SPECIAL FORCES RE- SPONSIBILITIES FOR TRAINING GUERRIL- LA FORCES.....	58-61	53
10. SPECIAL FORCES COM- MUNICATIONS.....	62-65	55
11. OPERATIONS.....	66-74	58
PART THREE. GUERRILLA FORCES		
CHAPTER 12. GUERRILLA FORCE AD- MINISTRATION.....	75,76	71
CHAPTER 13. GUERRILLA FORCE IN- TELLIGENCE		
Section I. Introduction.....	77,78	72
II. Guerrilla intelligence.....	79-82	72
III. Counterintelligence.....	83,84	79
CHAPTER 14. GUERRILLA FORCE OP- ERATIONS		
Section I. Organization and training.....	85,86	83
II. Marches and movements.....	87-89	85
III. Security Measures.....	90-95	86
IV. Offensive operations.....	96-109	89
V. Defensive operations.....	110-112	99
CHAPTER 15. GUERRILLA FORCE LO- GISTICS		
Section I. Supply.....	113-119	103
II. Medical service.....	120-126	107
CHAPTER 16. GUERRILLA FORCE COMMUNICATIONS		
Section I. Introduction.....	127-131	113
II. Means of communication.....	132-134	116
CHAPTER 17. RESUPPLY OPERATIONS		
Section I. Amphibious resupply opera- tions.....	135-138	120
II. Air resupply operations.....	139-142	123
APPENDIX I. REFERENCES.....		127
II. GLOSSARY.....		131
III. GUERRILLA INTELLIGENCE AGENCIES.....		133

APPENDIX IV. COMMUNICATIONS.....	146
V. GUIDE FOR TRAINING.....	155
Section I. General	155
II. Training phases	158
APPENDIX VI. GUIDE FOR LOGISTICAL SUP-PORT.....	160
VII. FIELD EXERCISE	165
INDEX	174

~~CONFIDENTIAL~~

~~CONFIDENTIAL~~

~~CONFIDENTIAL~~

PART ONE

SPECIAL FORCES GROUP ORGANIZATION AND MISSION

CHAPTER 1

GENERAL

1. Purpose and Scope

This manual is designed to assist the special forces group commander, his staff, and his detachment commanders in the organization and preparation for operational employment of all elements of the group. It is designed also to assist commanders and staffs of higher headquarters whose duty may require the wartime employment of a special forces group (airborne). It discusses the characteristics, principles, doctrine, and mission of the special forces group (airborne). The manual also discusses the phases of development, organization, support, and direction of guerrilla forces, consisting primarily of indigenous peoples and a minimum number of participating United States personnel and, equipment.

2. References (Unclassified)

For a list of references of subjects related to this manual, see appendix I.

3. Definitions (Unclassified)

For definitions of phrases and terms used in this manual, see appendix II

~~CONFIDENTIAL~~

4. Characteristics of the Special Forces Group (Confidential)

a. The group is a cellular type unit employed at theater level. It operates initially within the Army forces of the theater to conduct guerrilla operations (fig. 1). An appropriate command organization for the conduct of Unconventional Warfare may be organized as needed by the theater commander. Typical of an appropriate command organization is the joint unconventional warfare task force (JUWTF). This term is used throughout this manual.

b. The special forces group has the capability of operating within the framework of other theater organizational structures. In a large theater of operations, the theater commander or the commander of a joint unconventional warfare task force may organize one or more joint sectors for the purpose of coordinating, controlling, and supporting the unconventional warfare effort in designated areas. The special forces units are prepared to operate as a part of a joint sector force (fig. 2).

5. Mission (Confidential)

The primary mission of special forces units for guerrilla operations is to infiltrate operational detachments by air, sea, or land to designated areas within the enemy's sphere of influence in accordance with the approved plans of the appropriate area commander—

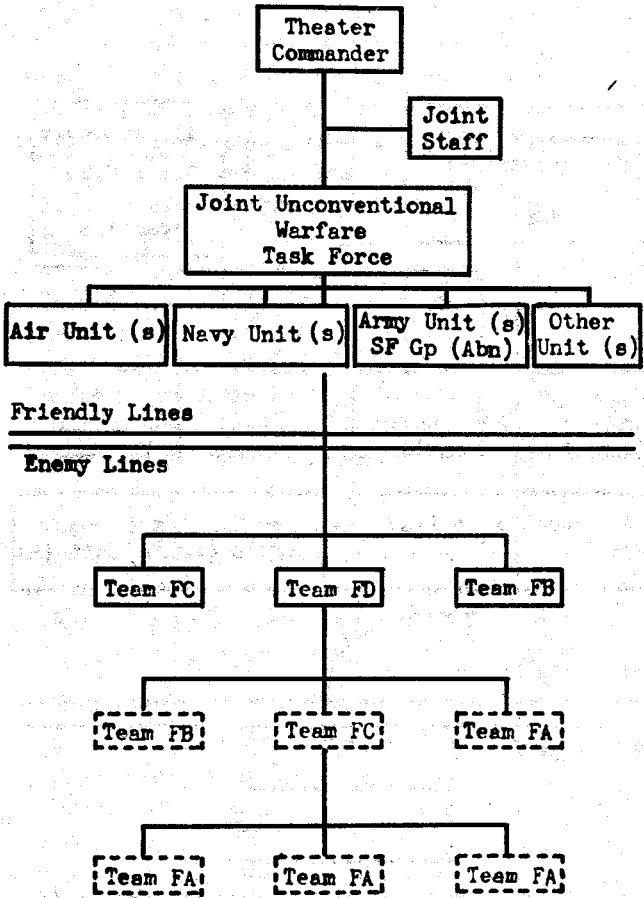

Figure 1. Position of the special forces group in theater structure.

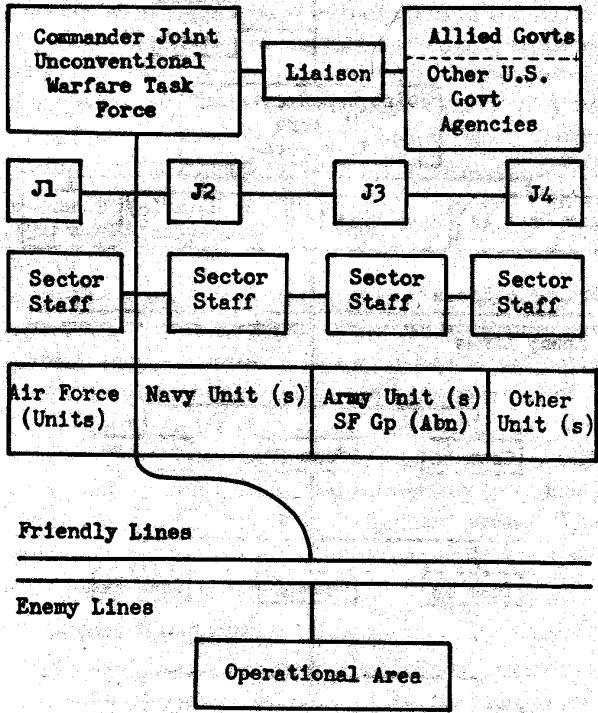

Figure 2. Organization of the joint unconventional warfare task force.

a. To develop, support; organize, train, or exploit indigenous guerrilla potential already generated or to be generated in support of conventional military operations and the national military objectives.

b. To provide appropriate specialists and advisors to assist, in achieving the above on a coordinated basis.

c. To perform such other missions that may be directed by the area commander, or that may be inherent in or essential to the primary mission of guerrilla warfare.

6. Operational Responsibility (Confidential)

After the operational teams are infiltrated into designated areas on assigned missions, the group commander, where headquarters will be augmented appropriately, will initially assume the responsibility for providing the necessary control and logistical support for these behind-the-lines units. As the size of the operation increases, a joint unconventional task force may be created to assume this responsibility and provide a more adequate command structure.

7. Composition (Unclassified)

a. The special forces group (airborne) consists of a headquarters and headquarters company, a quartermaster detachment (special forces parachute rigging), any required number of administrative teams, and any prescribed number of operational teams.

b. The details of organization, the allotment of weapons, and the distribution of items of

equipment are shown in current tables of organization and equipment.

8. Attachments (Unclassified)

Attachment of technical and service units to the group in a theater of operations should be made consistent with requirements for the support of the mission.

CHAPTER 2

SPECIAL FORCES GROUP HEADQUARTERS AND STAFF

Section I. THE UNIT STAFF

9. General

a. The unit staff of the special forces group assists the group commander in controlling the operations of the group as a whole.

b. The unit staff is similar in organization to an infantry regimental staff and performs similar duties. It is organized with an executive officer, S1, S2, S3, and S4. In addition to normal staff functions as prescribed in FM 101-5, duties as prescribed in paragraphs 10-14 are peculiar to the unit staff.

10. Executive Officer (Unclassified)

The executive officer is the senior assistant and advisor to the group commander. He coordinates and supervises the details of operations and administration, thereby enabling the commander to devote himself to the broader aspects of command. The principal function of the executive officer is the direction and coordination of the group staff. During absences of the group commander, the executive officer assumes command and directs the activities of the group in accordance with the policies of the group commander.

11. Adjutant (S1) (Unclassified)

a. The adjutant is responsible for the training and work of the S1 section. The section is divided between the adjutant and the personnel officer (par. 21).

b. Generally, the adjutant has duties similar to those for the adjutant general and the GI of division and higher units. He is responsible for the supervision of the personnel and administrative section, consisting of the adjutant, sergeant major, and designated clerks.

c. As adjutant, he has the following administrative functions—

- (1) Authenticates orders and instructions (non-tactical).
- (2) Processes official correspondence.
- (3) Insures that administrative and personnel records are maintained according to established policies and procedures.

d. As S1, he has the following specific duties—

- (1) Prepares strength records and reports.
- (2) Prepares data for the unit report.
- (3) Secures replacements and arranges for their reception and processing.
- (4) Maintains absence without leave statistics and supervises the processing of courtmartial cases.
- (5) Handles administration of confirmed deceased personnel.
- (6) Maintains morale activities in the group, such as recreation, decoration, citations, awards, honors, leaves, and passes. The

S1 coordinates with the chaplain and the surgeon on religious, welfare, and health matters.

- (7) Makes administrative recommendations about transfers, assignments, reassignments, promotions, classifications, and reclassification of personnel.
- (8) Supervises the establishment and the internal arrangement of the headquarters.
- (9) Secures and administers local indigenous labor (coordinates with S2).
- (10) Allots space and shelter in the base area for the troops and for the headquarters (coordinates with other staff sections).
- (11) Prepares estimates and plans covering personnel activities for current and future operations Topography.

12. Intelligence Officer (S2) (Unclassified).

a. The intelligence officer collects and disseminates information and intelligence concerning the enemy, terrain, and weather. He recommends counterintelligence measures to deceive or deny the enemy information regarding operations of the group. He is assisted by an assistant intelligence officer and an intelligence sergeant.

b. The S2 has the following specific duties—

- (1) Is responsible for the training and work of the group intelligence section.

- (2) Supervises the intelligence and counter-intelligence training of all personnel in the operational teams (coordinates with S3).
- (3) Formulates an intelligence collection plan.
- (4) Records and collects enemy information. He maintains the S2 work sheet and posts information on the situation map.
- (5) Evaluates and interprets information and disseminates intelligence to his commander, interested staff officers, higher headquarters, and the interested operational teams of the group.
- (6) When directed, he establishes the briefing facilities for operational teams (coordinates with S3).
- (7) Determines the requirements for maps, aerial photographs, and photomaps for distribution.
- (8) Determines the requirements for area studies and procures them from higher headquarters.
- (9) Supervises the counterintelligence measures within the group.
- (10) Prepares that portion of the briefing plan and unit report concerning enemy forces.
- (11) Coordinates all matters pertaining to intelligence and counterintelligence.

13. Operations and Training Officer (S3) (Unclassified)

a. The operations and training officer (S3) is responsible for the training and work of the group

operations section. He is assisted by an assistant operations officer, operations sergeant, draftsman, and clerks.

b. The S3 has the following specific duties which pertain to organization—

- (1) Makes a continuous study of group organization and prepares recommendations for changes to TOE.
- (2) Makes recommendations concerning the organization of the group for training and during combat (coordinates with other staff sees.).
- (3) Recommends priorities for personnel and equipment based on operational requirements (coordinates with other staff sees.).

c. The S3 has the following specific duties which pertain to training—

- (1) Plans and prepares training directives, programs, orders, and field exercises.
- (2) Selects and allocates training areas, ranges, training aids, and facilities (coordinates with S4).
- (3) Organizes and supervises officer, noncommissioned officer, and specialist schools within the group.
- (4) Conducts training inspections and prepares and supervises the execution of training tests.
- (5) Prepares and analyzes training records and reports.

14. Supply Officer (S4) (Unclassified)

a. The supply officer is responsible for the training and functioning of the group supply and maintenance section. He plans, coordinates, and supervises the operation of supply, evacuation, transportation, maintenance, and similar services within the group. He keeps in close contact with the operational team requirements and with the logistical staff section of higher headquarters.

b. The operating personnel which the S4 coordinates and supervises to accomplish his mission include the—

- (1) Assistant supply officer.
 - (2) Group supply and maintenance section that operates the group supply office and performs the duties assigned by the S4.
 - (3) Food advisor who maintains ration records, determines requirements, and maintains standards of food preparation for the command.
 - (4) Munitions officer who advises on matters pertaining to Class V supply.
 - (5) Motor officer who supervises vehicle maintenance and the control of transportation.
 - (6) Medical officer who supervises medical supply, evacuation of personnel, and sanitation.
 - (7) Parachute maintenance officer who provides parachute maintenance support to the group.
- c.* The S4 has the following specific duties—
- (1) Arranges for the procurement and packaging of supplies for operational teams.

- (2) Recommends the location of supply and maintenance installations within the group.
- (3) Supervises the location of supply and maintenance installations.
- (4) Assists the detachment and team commanders in supply matters.
- (5) Coordinates logistical matters with higher and supporting headquarters.
- (6) Supervises the administration of sanitary measures (coordinates with medical officer).
- (7) Coordinates and prepares administrative orders and assists in the preparation of briefing plans.
- (8) Supervises the organization and maintenance of supply records.
- (9) Plans and programs supply and transportation requirements based on training requirements (coordinates with S3).

Section II. THE SPECIAL STAFF

15. General (Unclassified)

The special staff consists of staff officers and commanders of special units whose functions, performed in close coordination with the unit staff, are intended to assist the group commander in the employment of special units and in the coordination of special activities within the group. The group special staff consists of—

- a.* Commanding officer, operational detachment, area, (prior to commitment). See paragraph 35.
- b.* Communications officer.

- c.* Headquarters commandant.
- d.* Food advisor.
- e.* Motor officer.
- f.* Personnel officer.
- g.* Chaplain.
- h.* Medical officer.
- i.* Parachute maintenance officer.
- j.* Munitions officer.
- k.* Commanders of attached and supporting units.

16. Commanding Officer, Operational Detachment, Area (Unclassified)

a. This officer is unit commander of the team FD (par. 35). Prior to commitment of his team, he assists the group commander in training and preparing operational teams for commitment.

b. The commanding officer has the following specific duties—

- (1) Makes recommendations regarding implementation of the group-training program.
- (2) Makes recommendations for commitment of operational teams.
- (3) Makes recommendations for the assignment of operational areas.
- (4) Keeps informed of the tactical situation and prepares plans and estimates for the future employment of his operational teams.
- (5) Assists the group commander in all matters concerning the command, when so directed.

17. Communications Officer (Unclassified)

a. The communications officer supervises and coordinates the, training and activities of communica-

tions personnel assigned to the group. He directs the operations of the group communications section. The communications officer bases his actions upon the policies, mission, and plan of his commander. He keeps himself fully informed of present and contemplated activities of the group.

b. Included in the communications officer's principal duties are the following:

- (1) Advises the commander and his staff on signal matters and makes plans and recommendations for establishing the communications system.
- (2) Supervises the installation, operation, and maintenance of the communication system.
- (3) Coordinates communications matters with higher; adjacent, supporting, supported, and attached units.
- (4) Supervises the care, maintenance, and replacement of communications equipment in the group and advises, S-4 on supply of communications equipment.
- (5) Supervises the maintenance of communications security including the use of codes, ciphers, and authentication systems.
- (6) Assists S1 in the assignment, procurement and replacement of communications personnel.
- (7) Assists S3 in the, preparation of training directives and programs for communications personnel within the group.

- (8) Prepares for approval (or secure from higher headquarters) standing signal instructions (SSI), signal operations instructions (SOI), and standing operating procedures (SOP) relative to communications and communications security. He is responsible for their distribution.
- (9) Submits recommendations, for the communications paragraph, of operations orders, including initial and subsequent command post locations to include locations of communications installations therein.

18. Headquarters Commandant (Unclassified)

a. The headquarters commandant also commands the group headquarters company. He performs his duties with the assistance of the company headquarters personnel.

b. The headquarters commandant has the following specific duties

- (1) Supervises the physical establishment of the headquarters.
- (2) Supervises the messing and briefing of the headquarters personnel.
- (3) Supervises and administers indigenous labor.
- (4) Assists S4.
- (5) Provides for the security of the headquarters (coordinates with S2).
- (6) Enforces traffic control regulations within the group area (coordinates with S2).

19. Food Advisor (Unclassified)

a. The food advisor is the principal assistant to the group commander on matters pertaining to the preparation and serving of food. He is assisted by the food service specialist in the supply and maintenance section. His activities are supervised by S4.

b. The food advisor has the following specific duties—

- (1) Develops measures for the improvement of food service, food consumption, and the elimination of food waste.
- (2) Studies food qualities and quantities, mess operation, food preference, and related matters.
- (3) Inspects to insure mess operation instructions are being followed.
- (4) Supervises the training of food service personnel assigned to the administrative teams (coordinates with S3 and S4).
- (5) Makes recommendations for the training of operational teams in the preparation of special types of rations.

20. Motor Officer (Unclassified)

a. The motor officer is the principal assistant to the group commander concerning automotive maintenance and the control of transportation. He is assisted by maintenance personnel assigned to the group supply and maintenance section. He is supervised by S4.

b. The motor officer has the following specific duties

- (1) Supervises vehicle maintenance.
- (2) Controls motor transportation operating under group control and not assigned to other officers of the group echelon.
- (3) Makes recommendations concerning control and use of group transportation.
- (4) Inspects to insure that, maintenance is being properly performed within the group.

21. Personnel Officer (Unclassified)

a. The personnel officer, together with the personnel sergeant, personnel administrative supervisor, and clerks assigned to the personnel and administrative section, maintains the operational team and group records, reports, rosters, strength returns, and personnel files. The personnel officer is designated the assistant adjutant (par. 11). He is charged with the preparation, maintenance, and safekeeping of records, documents, correspondence, and statistics of a personnel and administrative nature.

b. The personnel officer has the following specific duties—

- (1) Administers all operational team personnel records of which he is custodian.
- (2) Acts as custodian for group funds.
- (3) Furnishes the disbursing officer with military pay orders as required.
- (4) Maintains the account for confidential funds.

- (5) Assists the operational team leaders and relieves them when practicable in preparation of rosters and lists required by higher headquarters.
- (6) Based on records maintained under his supervision, he advises and assists operational team leaders in the assignment and classification of personnel.
- (7) Trains replacements for clerks working with the group staff.

22. Chaplain (Unclassified)

a. The group chaplain is usually the senior of two chaplains assigned to the group headquarters, He is charged with the spiritual and moral welfare of the command.

b. The group chaplain has the following specific duties—

- (1) Supervises the spiritual welfare of the command.
- (2) Conducts religious services and ceremonies.
- (3) Corresponds with relatives of deceased personnel.
- (4) Coordinates the religious work of any welfare society that may operate with the command.
- (5) Supervises and coordinates the work of the other chaplains:
- (6) Acts as custodian of any funds authorized by religious activities.

- (7) Makes recommendations to the operational team leaders regarding religious activities and burial procedures in operational areas.

23. Medical Officer (Unclassified)

a. The medical officer supervises the medical service of the group and commands the medical section of group headquarters. He advises the commander and staff in all matters pertaining to medical support of the command.

b. The medical officer has the following specific duties—

- (1) Supervises the instruction, of the group in personal hygiene, military sanitation, and first aid.
- (2) Conducts medical and sanitary inspections.
- (3) Establishes and operates the dispensary at the base.
- (4) Is responsible for the procurement, storage, and issue of medical supplies required for the medical service of the group (coordinates with S4).
- (5) Maintains contact with the medical officer of the next higher headquarters, keeping him informed of the medical support requirements and other information that will facilitate medical support of the operational teams in the area of operations.
- (6) Prepares medical and sanitary records and reports pertaining to the medical service.
- (7) Procures medical area studies of planned areas of operation and makes

recommendations to the group commander for medical training requirements in these areas (coordinates with S3).

- (8) Makes recommendations for the utilization of medical officers assigned to the group.
- (9) Supervises the technical training of all medical personnel assigned within the group (coordinates with S3).
- (10) Initiates immunization programs for personnel assigned to plan areas of operation (coordinates with S1 and S3).

24. Parachute Maintenance Officer (Unclassified)

a. The parachute maintenance officer supervises the parachute maintenance activities within the group. He also commands the quartermaster special forces parachute rigging detachment that is normally assigned to the group.

b. The parachute maintenance officer has the following specific duties—

- (1) Supervises the repair and packing of personnel and cargo parachutes for the group.
- (2) Provides qualified riggers for group personnel preparing for parachute jumps.
- (3) Supervises the rigging of cargo and equipment.
- (4) Supervises the recovery of parachutes and allied equipment for drops not in combat areas.
- (5) Maintains records and reports relative to packing data and accountability of parachutes.

- (6) Advises the group commander on parachute maintenance requirements..
- (7) Procures parachutes and allied equipment to support group operations (coordinates with S4).
- (8) Establishes parachute packing and maintenance facilities at the special forces base.

25. Munitions Officer (Unclassified)

a. The munitions officer is the principal assistant to the group commander in matters pertaining to Class V supply. He functions within the supply and maintenance section of the group headquarters. He is supervised by S4.

b. The munitions officer has the following specific duties—

- (1) Makes recommendations concerning Class V supply.
- (2) Prepares the required ammunition records and requests.
- (3) Processes training ammunition requirements.

26. Commanders of Attached or Supporting Units (Unclassified)

a. Commanders of attached or supporting units, or their liaison representatives, advise the group commander and staff on the use of their units.

b. Commanders of attached or supporting units have the following specific duties—

~~CONFIDENTIAL~~

- (1) Submit plans and recommendations for the employment of their units based on the group mission.
- (2) Coordinate their activities with group agencies and the operational teams.

CHAPTER 3

SPECIAL FORCES ADMINISTRATIVE UNITS

27. General (Unclassified)

a. The special forces group (airborne) contains the necessary administrative units to support the headquarters and the operational teams prior to combat operations and, with such augmentation as the situation may require, to support them during combat operations. Types of administrative units normally assigned are the headquarters and headquarters company, the quartermaster special forces parachute rigging detachment, team AA (administrative detachment, company) and team AB (administrative detachment, battalion).

28. Headquarters and Headquarters Company (Unclassified)

a. Capabilities. The headquarters company (fig. 3) of a special forces group is organized to give it the following capabilities

- (1) Command, staff control, and planning for a special forces group located in rear areas.
- (2) Distribution of supplies to a special forces group located in friendly areas.
- (3) Organizational maintenance for a special forces group located in friendly areas.
- (4) Administration for a special forces group.
- (5) Supervision of training.

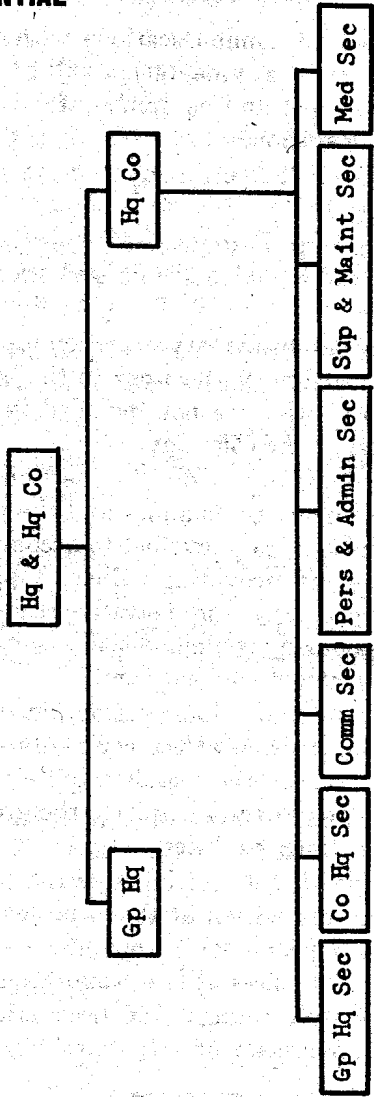

Figure 3. Organization of headquarters and headquarters company, special forces group (airborne).

- (6) Nontactical communications with subordinate units. Augmentation will be required in personnel and equipment for any large-scale operation.

b. Composition. The company is made up of the following elements

- (1) The group headquarters consists of the commander and his unit and special staff officers.
- (2) The group headquarters section is composed of enlisted men who work in the headquarters and who are not included in another section of the company.
- (3) The company headquarters section includes the company commander and the necessary administrative personnel to accomplish the mission of providing billets, supply, and other company administrative requirements. The company commander also serves as the headquarters commandant.
- (4) The communications section, under the direct supervision of the communications officer, contains the necessary enlisted personnel to operate and maintain the group communications facilities.
- (5) The personnel and administrative section, under supervision of the adjutant contains enlisted personnel to operate the S1 and personnel offices of the group headquarters.
- (6) The supply and maintenance section, under the supervision of S4, contains the officer and enlisted personnel required to operate

the supply and maintenance functions of the group.

- (7) The medical section, under the supervision of the command medical officer, consists of the general medical officers, medical service officers, dental officers, and the necessary enlisted personnel to support the medical requirements of the group.

29. Quartermaster Special Forces Parachute Rigging Detachment (Unclassified)

a. Capabilities. The quartermaster parachute rigging detachment (fig. 4) is organized to provide parachute maintenance support to a special forces group.

b. Composition. The detachment consists of a detachment headquarters and three squads: supply, maintenance, and packing. For detailed organization, see the current table of organization and equipment.

30. Administrative Teams (Unclassified)

a. Team. AA, Administrative Detachment, Company. This team, when attached to a team FB, provides the necessary mess and administration for a nonoperational grouping of nine or more teams FA. After the operational teams are committed, team AA is available for augmenting the administrative functions of the group.

b. Team AB, Administrative Detachment, Battalion. This team, when attached to a team FC, provides the necessary administration for a nonoperational

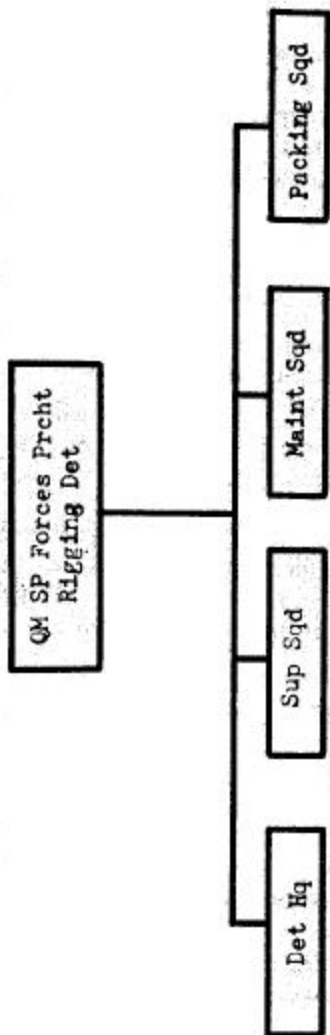

Figure 4. Organization of quartermaster parachute rigging detachment, special forces group (airborne).

~~CONFIDENTIAL~~

grouping of, 45 or more teams FA. After operational teams are committed, team AB is available for augmenting the administrative functions of the group.

~~CONFIDENTIAL~~

CHAPTER 4

SPECIAL FORCES OPERATIONAL TEAMS

31. General (Confidential)

a. The special forces group (airborne) contains cellular operational teams which represent group's primary training responsibility. The operational teams are identified by using letter combinations to indicate their relative operational levels after deployment.

b. Each operational team has the capability of organizing and developing a guerrilla force. This guerrilla force has the following inherent capabilities

- (1) To conduct guerrilla warfare in support of conventional military operations.
- (2) To augment the execution of theater policies in the conduct of political, economic, sociological, and psychological, operations.
- (3) To conduct clandestine operations. These operations include intelligence, security, evasion and cape, and sabotage, as they become essential for supporting the conduct of guerrilla operations.
- (4) To conduct raider type operations.
- (5) To conduct such other related operations as directed.

c. All interrelated operations falling within these capabilities will be coordinated with agencies

having primary responsibility and in concert with theater plans and policies.

d. For control, administration, and training, the special forces group is organized in a provisional manner along the conventional lines of a regiment. The group headquarters and headquarters company retains its identity and organization, as does the parachute rigging detachment. The team FC augmented by a team AB forms a provisional battalion headquarters to which may be attached approximately five teams FB. Each team FB augmented by a team AA forms a provisional company headquarters to which are attached approximately nine teams FA (fig. 5).

32. Team FA, Operational Detachment, Regimental (Confidential)

a. Organization. The team FA is composed of a unit commander, executive officer, chief medical technician, platoon sergeant, heavy and light weapons leaders, demolitionists, and radio operators. For detailed organization, see current tables of organization and equipment.

b. Mission. The team FA infiltrates to a designated area within the enemy's sphere of influence and organizes a guerrilla regiment and/or performs such other related missions as directed.

33. Team FB, Operational Detachment, District B (Confidential)

a. Organization. The team FB is composed of a unit commander, executive officer, S1, S2, S3, S4, chief medical technician, platoon sergeant, enlisted

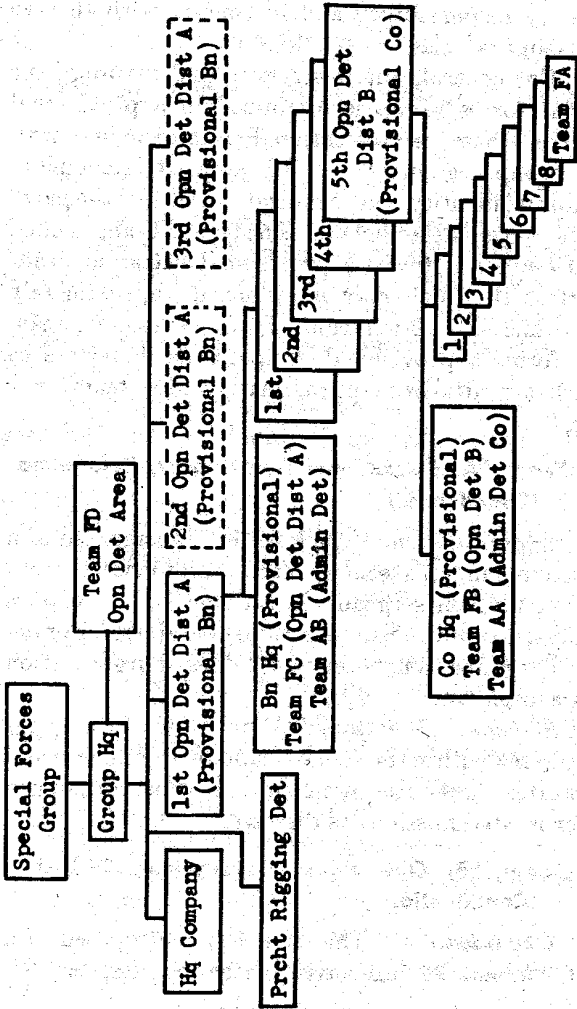

Figure 5. Nontactical organization of the special forces group.

assistants to the staff, radio operations supervisor, radio repairmen, and demolitionists. For detailed organization, see the current table of organization and equipment.

b. Mission. The team FB infiltrates to a designated area within the enemy's sphere of influence and organizes a district command composed of two or more guerrilla regiments and/or performs such other related missions as directed.

34. Team FC, Operational Detachment, District A (Confidential)

The team FC is organized in a manner similar to that described in paragraph 33 for the team FB. The difference between teams FB and FC is that all officers in team FC are one grade higher than their counterparts in team FB. The team FC has the capability of organizing a larger district and of dealing more effectively with high ranking guerrilla leaders.

35. Team FD, Operational Detachment; Area (Confidential)

The team FD is organized in a manner similar to teams FB and FC. The principal difference is that the officer ranks are one grade higher than those of team: FC. The team FD has the mission of infiltrating to a designated area within the enemy's sphere of influence and organizing an area command composed of two or more district commands, and of performing such other related missions as may be directed.

PART TWO
SPECIAL FORCES GROUP FUNCTIONS
AND OPERATIONS

CHAPTER 5
THE SPECIAL FORCES BASE

Section I. INTRODUCTION

36. General (Confidential)

a. Immediately after arrival in a theater of operations, the special forces group commander may be directed to establish and organize a special forces base. When directed this base will augment the control and support facilities of the joint unconventional warfare task force.

37. Mission (Unclassified)

The mission of the special forces base: is to provide—

a. Command, administration, training, technical, and logistical support required by the operational teams prior to commitment to the operational area.

b. Administrative support required in the operational area, as directed.

38. Location (Unclassified)

The location of the special forces base is prescribed by higher headquarters. The group commander, in making location recommendations to higher

headquarters, will consider that the base should be located

- a.* In a nontactical area of reasonable stability.
- b.* Near supply services and transportation facilities.
- c.* Where adequate communications routes and facilities, are available.

39. Organization (Unclassified)

The special forces base will be organized and operated as required to provide the following facilities in the accomplishment of assigned missions (fig. 6)

- a.* Command and staff structure.
- b.* Administrative facilities.
- c.* Logistical facilities.
- d.* Technical support facilities.
- e.* Training facilities.

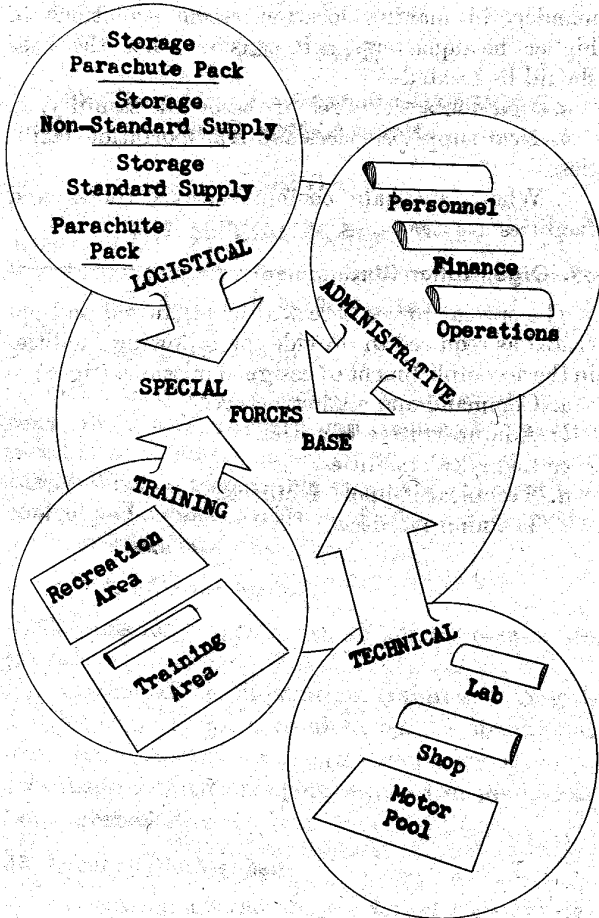

Figure 6. The special forces base.

Section II. COMMAND AND STAFF STRUCTURE

40. Command (Unclassified)

The special forces group commander will establish and command the special forces base and, through his staff, provide the required facilities.

41. Staff (Confidential)

In addition to the normal staff functions as prescribed in FM 101-5, the following duties are peculiar to the special forces base staff

a. S1—

- (1) Establishes facilities for recruits and processes indigenous operational personnel.
- (2) Arranges for possible utilization of indigenous administrative personnel.
- (3) In coordination with S2, arranges for the administrative processing of correspondence for operational team personnel, and maintains correspondence with dependents of operational team personnel.
- (4) Prepares standing operating procedures to cope with emergency situations of a personal nature that may affect operational team personnel.
- (5) In coordination with S4, establishes the necessary supply facilities to fulfill personal requirements of operational personnel.
- (6) Establishes the necessary facilities and personnel, and implements guidance and

policies for the use of confidential funds as directed by higher headquarters.

b. S2—

- (1) In coordination with S3, supervises the physical security of the base.
- (2) In coordination with S3, is responsible for training operational, intelligence personnel.

c. S3—

- (1) Supervises the field-testing of operational training, communications; and resupply procedures prior to commitment.
- (2) Determines and supervises the training of selected foreign personnel.

Section III. BASE FUNCTIONS

42. Administrative Facilities (Confidential)

In the establishment of the special forces base, administrative facilities such as messing, billeting, and recreation within the base area will be required for—

- a. Operational team personnel.
- b. Administrative personnel, including counter-intelligence and military police.
- c. Attached technical personnel.
- d. Foreign operational personnel.

43. Logistical Facilities (Unclassified)

The special forces group S4, assisted by representatives of the attached services, will establish and maintain logistical facilities necessary, to comply with the theater directives.

44. Technical Services (Confidential)

The special forces base will require augmentation from the technical services in order to carry out its mission. The augmentation will depend primarily on the time available for the selection and training (if indigenous personnel. These personnel will be utilized as instructors, supply specialists, and technicians. The following technical, services will be required:

- a.* Signal.
- b.* Ordnance.
- c.* Quartermaster.
- d.* Transportation.
- e.* Medical.

45. Training Facilities (Confidential)

Adequate training facilities will be established by S3 to insure that all required training is properly conducted for operational teams and personnel. Training facilities will include—

- a.* Joint communication facilities.
- b.* Joint amphibious, training sites.
- c.* Language and area training facilities.
- d.* Joint airborne testing areas.
- e.* Agent training facilities.

46. Staging and Briefing Center (Confidential)

a. The theater commander or the commander of the joint unconventional warfare task force will direct the establishment of staging and briefing facilities. The special forces group commander may be required to establish, organize, and operate a staging and briefing center.

b. Special forces operational teams are processed through staging, and briefing centers prior to their operational commitment. These centers are isolated installations which are so compartmented that personnel or units for different missions have no opportunity for contacting one another. When equipped, and given final instructions, personnel or units are infiltrated by air, sea, or land to designated areas of operation.

c. The operational briefing provides detailed guidance required by operational teams for the successful accomplishment of their missions.

CHAPTER 6

SPECIAL FORCES ADMINISTRATION

47. General (Unclassified)

This chapter is concerned with a discussion of administrative matters relating to the special forces group before and after commitment of operational teams. For detailed organization and administrative responsibilities, see the current table of organization and equipment.

48. Group Adjustments After Commitment of Operational Teams (Confidential)

a. When the commitment of operational teams to combat reduces the strength to the point that provisional companies and battalions are no longer required, the group commander must reorganize the group. The provisional company and battalion headquarters cease to exist at the time the operational teams go to the staging and briefing center. The teams AA and AB. remain behind and revert to the control of the group commander. The personnel administration and interior management of the headquarters and headquarters company and of parachute rigging detachment remain essentially the same as prior to the commitment of the operational teams.

b. The administrative teams, upon reverting to the group commander's control, form a pool of personnel and teams which the commander may use

as he deems fit. Some of the purposes for which they maybe utilized are

- (1) Attachment to new provisional units undergoing training to provide them administrative support.
- (2) Attachment to groupings of, teams recovered from enemy territory to furnish them administrative support
- (3) Augmentation of the headquarters' and headquarters company and the parachute rigging detachment.

49. Administrative Support to Committed Teams (Unclassified)

a. Personnel administration is decentralized to the maximum extent possible in order to lessen the number and frequency of reports. A detailed briefing will be given to the operational team leaders on the personnel policies and procedures under which they will operate. This briefing will define the latitude which the teams may take in interpreting these policies and procedures.

b. Prior to departure of the operational teams for the operational area, a complete personnel processing of each man is effected. This processing will be performed in accordance with standing operating procedures.

50. Administrative Problems of Operational Teams After Commitment (Confidential)

Upon commitment, operational teams are relieved of all administrative records and reports that can be maintained by the special forces group. However, the ranking operational leader in an area,

as well as the leaders of teams assigned' to individual missions; remain fully responsible for the efficient employment and welfare of special forces personnel under their jurisdiction. Morale and welfare considerations will include provisions for awards and decorations. Adequate policies and arrangements regarding disciplinary matters involving United States personnel, relations with civil populations, and employment of indigenous civilians must be developed frequently on a basis of agreement with the indigenous commanders involved.

51. Administrative Guidance to Guerrilla Units (Confidential)

a. Special forces team personnel at all levels will come to appreciate that the administration of guerrilla forces is complicated by a variety of ethnic, psychological, political, and economic factors with which commanders of conventional forces are not ordinarily faced. Factors pertaining to the basic motivation of resistance groups, guerrilla relations with the local population, potential civilian sources of recruits, local customs, and religious practices will all have a bearing on the administrative policies adopted by guerrilla commanders in the area.

b. Aided by a sympathetic understanding of the framework in which guerrilla operations must be conducted, the special forces area leader works through existing channels of the guerrilla command to gain acceptance of basic theater policies and procedures. Through his working relationship at guerrilla area headquarters, and by the closely

~~CONFIDENTIAL~~

coordinated efforts of his special forces subordinates at district and regimental levels, he attempts to assist the guerrilla forces in solving its administrative and personnel problems.

c. As new problems arise or are foreseen in connection with guerrilla force personnel policies and procedures, discipline, morale, finance, and relations with civilian elements, special forces personnel should be prepared to assist promptly in the working out of solutions acceptable to all parties.

~~CONFIDENTIAL~~

CHAPTER 7

SPECIAL FORCES INTELLIGENCE

52. General (Unclassified)

Complete intelligence concerning the area of operations should be made available to the operational team leader during his operational briefing.

53. Requirements (Unclassified)

Intelligence essential for special forces planning and operations may include—

a. Basic Intelligence.

- (1) Geography.
- (2) Target and target systems.
- (3) Enemy stockpiles.
- (4) Critical industries.
- (5) Meteorology.
- (6) Oceanography.
- (7) Light data.
- (8) Ethnology.
- (9) Political background.
- (10) Religious background.

b. Armed Forces. History, organization, personnel, armament, equipment, strategy, tactics, techniques, doctrine, logistics, supply lines, installations, order of battle, current operations, and dispositions.

c. Enemy Security Forces. Strength, organization, location, control, method of operating, local informers, and coordination.

d. Enemy Intelligence and Counterintelligence Agencies and Activities.

e. Scientific and Technical Developments.

f. Current Political Situations.

g. Current Economic Situations.

h. Manpower.

i. Resistance or Guerrilla Groups. Location, strength, organization, personalities, politics, and available contacts.

54. Intelligence Planning and Organization (Confidential)

Intelligence planning must make allowance for the time and space factors involved in the processing of information from the operational area. Operational teams sent on assigned missions with guerrilla units must be able to brief the guerrilla commander on the intelligence requirements and train key intelligence personnel within the guerrilla unit. The operational teams will determine the adequacy of the guerrilla organization for intelligence and counterintelligence, and will supervise the expansion of the guerrilla intelligence collection facilities through the establishment of clandestine intelligence nets.

CHAPTER 8

SPECIAL FORCES TRAINING

55. General (Unclassified).

The special forces group has the primary mission of training operational and administrative teams. The special forces group commander is responsible for the training of the group.

56. Organization for Training (Unclassified)

The commander will normally organize his group for training under a provisional structure as illustrated in figure 5.

57. Conduct of Training (Confidential)

a. Training will be conducted in accordance with the current army training program (ATP) and training directives.

b. The post cycle phase includes the selection of teams for area assignments and is undertaken after the group has attained the training objectives of the ATP. Post cycle training has three major objectives—

- (1) Selection, training, and preparation of teams for specific areas of operations. Preparation includes training the operational team members in the language, geography, economy, customs, religion, technology, history, institutions, local

maps, travel restrictions, rationing, and local security.

- (2) Improvement of team capabilities by repetition or elaboration upon previously received training.
- (3) Expansion of individual capabilities by intensive training of team members in the specialist skills of other members of the team.

CHAPTER 9

SPECIAL FORCES RESPONSIBILITIES FOR TRAINING GUERRILLA FORCES

58. General (Confidential)

The special forces team leaders are responsible for assisting guerrilla commanders in the training of their units. Schools for specialist training may be established at various guerrilla headquarters. Selected guerrillas may be evacuated from the operational area to the special forces base for specialized training under the supervision of the special forces group commander. The conduct of guerrilla training under the special forces operational team leader's program will require close personal supervision on his part. Special forces personnel are trained to, instruct indigenous forces and will aid the guerrilla commander in the implementation of the program.

59. Estimate of the Training Situation (Confidential)

The operational team leader will make an estimate of the training situation as soon as possible after infiltration. The estimate of the training situation is a continuous function of the team leader, and will consider available manpower, indoctrination, status of training, morale, and equipment.

60. Planning Guerrilla Training (Confidential)

The team leader, based on his mission and his estimate of the training situation, will advise the guerrilla commander, on training; requirements. The principles involved in drawing up the training program parallel those of a program for conventional troops. It is important that the team leader develops a sound, workable program early in his operation keyed to the guerrilla needs and that the plan is acceptable to the guerrilla commander. The team leader must insure the coordination of administrative and logistical arrangements to implement the plan.

61. Evaluation of Guerrilla Capabilities (Confidential)

The operational team leader must assess the guerrilla unit capabilities for the benefit of those engaged in making current and future plans for their employment. Evaluation of guerrilla troops presents a more complex problem than estimating the fitness of conventional troops.

CHAPTER 10

SPECIAL FORCES COMMUNICATIONS

62. General (Unclassified)

A unified communications system is required for the exercise of command, control, and coordination. Communications interests of special forces and other theater services overlap. Maximum use will be made of alternate means of communications and theater signal facilities. In planning, the establishment of a communications system, the special forces group commander and his staff consider and evaluate—

- a.* Physical distances that separate the subordinate units of the command.
- b.* Topography of the area over which the communications system must operate.
- c.* Communications facilities needed by lower units to perform their missions.
- d.* Communications security requirements.
- e.* Supply and resupply procedures.
- f.* Technical assistance and training requirements.

63. Signal Staff Section (Unclassified)

a. The signal officer on the staff of the, special forces group commander is the advisor on all matters pertaining to signal communications.

b. Principal, duties of the signal officer, consist of training signal communications personnel and providing for the supply of signal communications

equipment. Additional responsibilities of the signal officer include—

- (1) Supervising the communications system headquarters.
- (2) Coordinating signal communications requirements with other, headquarters.

64. Radio Nets (Confidential)

The radio network will consist of several nets which are established and expanded in conjunction with the progressive organization and expansion of the guerrilla forces in the enemy-controlled area. These radio nets will normally include

a. Administrative Net. To provide communications between the special forces base and other headquarters.

b. Command Net. To provide for the flow of all scheduled "blind" broadcasts and emergency traffic between the base headquarters and the operational teams.

c. Operational Net. To provide lateral communications between operational teams.

d. Guerrilla Net. To provide the internal communications required by the guerrilla forces for administrative and operational control.

65. Communications Training (Unclassified)

Training of special forces communications specialists must include an intensive period of formal school instruction. Practical field training should begin immediately upon completion of formal school training, and should be conducted on a continuing basis until such time as the unit becomes operational. The training program must include a maximum of

practical field training under conditions involving terrain and distances that will realistically simulate conditions encountered in an actual operational area. Capabilities and limitations of radio equipment employed in field training should conform as closely as possible to these of radios employed in an operational area. Cryptographic systems employed during field training should also conform as closely as security will permit to those systems employed during actual operations.

a. Particular emphasis should be placed on the training of communications personnel in the use of field expedients. Training of radio operators should include intensive training in operating, equipments through: jamming and atmospheric noises.

b. Communications personnel should be crosstrained to insure continuous operations of communications despite the attrition of personnel behind enemy lines.

c. All members of the Special Forces Group who will operate behind enemy lines should receive a basic communications orientation course.

CHAPTER 11

OPERATIONS

66. General (Confidential)

Operations conducted by special forces may be defined broadly as those operations involving the organization, build-up, and final exploitation of the guerrilla potential within enemy territory. Operations are started as soon as possible within the capability of the force, and increase in dimension as the force grows. The guerrilla should retain the initiative, even though the action involved may be relatively small. Such small actions early may be the most helpful to our conventional forces, for then is their time of greatest need for assistance.

67. Phases (Confidential)

The development of guerrilla forces progresses through the following overlapping phases—

- a.* Phase I*—psychological preparation.
- b.* Phase II*—initial contact with resistance elements.
- c.* Phase III—infiltration of special forces operational teams.

*Phases I and II should be conducted prior to D-day by Governmental organization other than Special Forces. However if these phases have not been accomplished prior to Dday, phases I, II, and III will be carried out simultaneously by Special Forces Operational Teams.

d. Phase IV—military organization of guerrilla forces.

e. Phase V—build-up of guerrilla forces.

f. Phase VI—military exploitation of guerrilla forces.

g. Phase VII—administrative.

68. Phase I—Psychological Preparation (Confidential)

(Fig. 7)

a. Resistance in some degree is found in the mind of any man who subconsciously desires to rid himself of his conquerors or oppressors. How rapidly and logically this buried desire can be brought into the open and put to use in a resistance movement depends on several factors

- (1) The harshness or weakness of the enemy's military, administrative, and psychological control measures.
- (2) The sociological, political, and economic characteristics of the people.
- (3) The psychological warfare operations conducted by U.S. agencies or by agencies of allied governments-in-exile. These overt and covert preparatory operations encourage, direct, support, and exploit the resistance spirit as it evolves into guerrilla movements.

b. Some men are active in a resistance movement as it begins, and some are passive. The guerrilla movement must have the moral and material support of the local elements. Accordingly, psychological

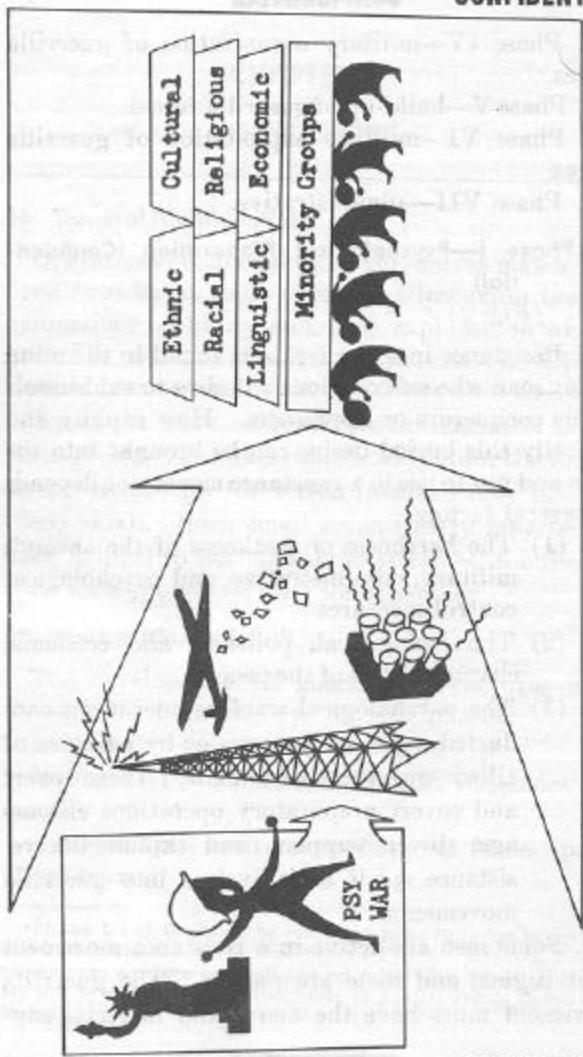

Figure 7. Phase I of guerrilla development—psychological preparation.

warfare operations seek to unify the spirit of resistance, mold the population into a sympathetic and supporting mood, and convince both the active and passive elements of the likelihood for ultimate victory and liberation.

c. In addition, psychological warfare operations throughout phases III through VI are conducted in support of guerrilla operations by

- (1) U.S. governmental agencies in coordination with allied governments-in-exile.
- (2) U.S. military agencies in the theater of operations, as directed.
- (3) Special forces operational teams in coordination with guerrilla organizations, as directed.

d. For further information on psychological warfare operations, see FM 33-5.

69. Phase II—Initial Contact With Resistance Elements

(Confidential)

(Fig. 8)

a. During this phase highly trained agents are infiltrated, into the operational area. The mission of these individuals is to establish contact with resistance or guerrilla groups. They will transmit to the responsible agencies such information as—

- (1) Activities of resistance or guerrilla groups.
- (2) Potential of such groups.
- (3) Attitude of the population.
- (4) Political considerations.

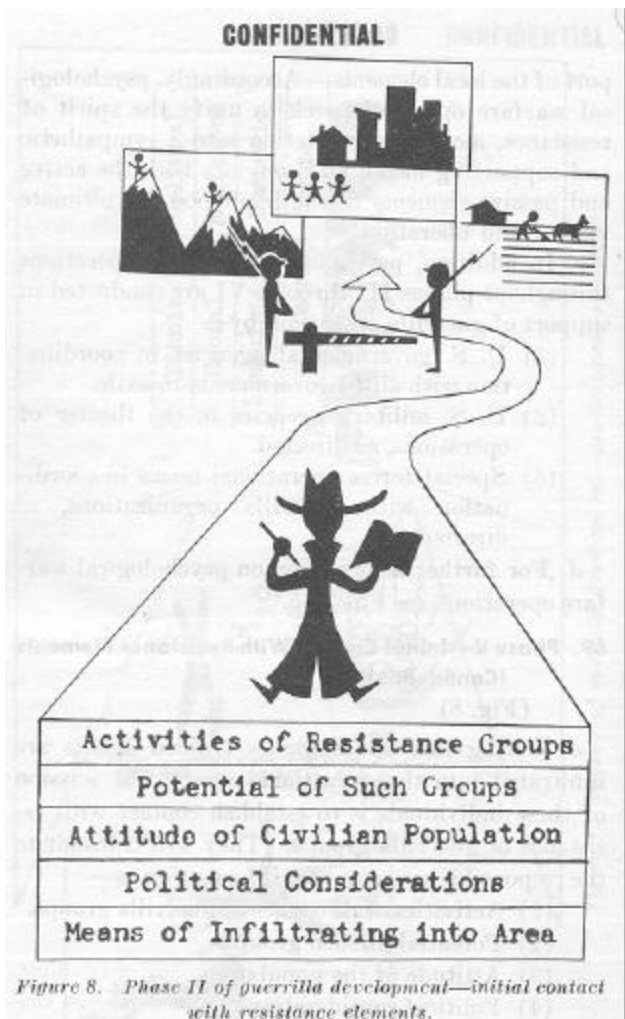

(5) Enemy forces and methods available for the delivery of personnel and equipment to the area.

b. The time factor for the accomplishment of the first two phases will vary in each situation. The success of future operations will be greatly enhanced if phases I and II have been accomplished prior to D-day.

70. Phase III—Infiltration of Special Forces Operational Teams (Confidential)

(Fig. 9)

Selected and trained U. S. military personnel enter the operations area as soon as possible after conventional hostilities have been declared. The selection of initial units is based on intelligence of the guerrilla potential in the operations area, political considerations, and the operational requirements. Based on this information, experienced teams are selected, thoroughly briefed, and infiltrated into designated areas. As the guerrilla potential increases and our logistical capacity expands, additional operational teams are infiltrated. Several guerrilla organizations may be developed simultaneously in this manner . The only limiting factor may be the ability to provide these organizations with required logistical support.

71. Phase IV—Organization (Confidential)

(Fig. 10)

a. The team leader and the guerrilla commander discuss their respective situations and establish the position of the special forces team members with

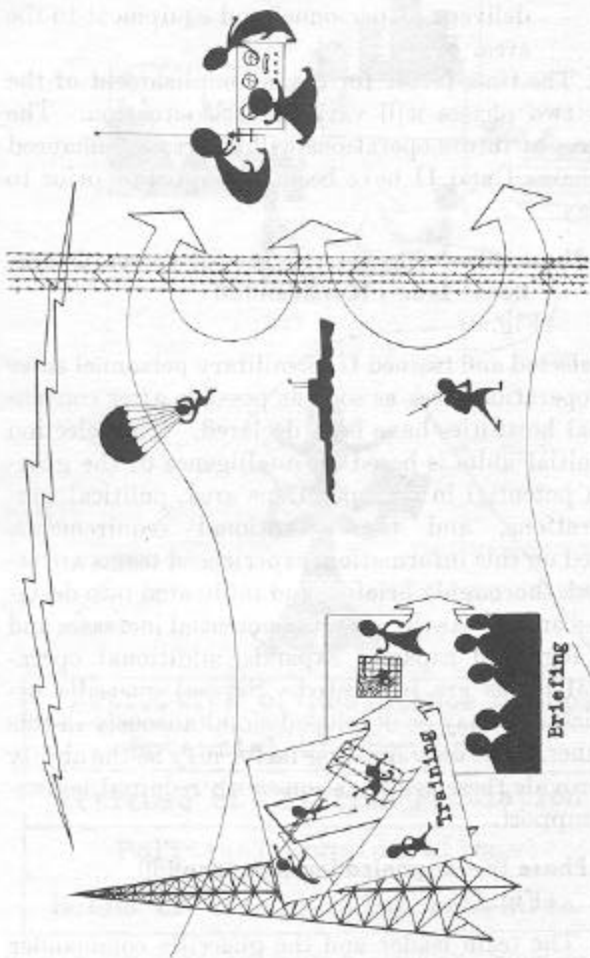

Figure 9. Phase III of guerrilla development—infiltration of special forces operational teams.

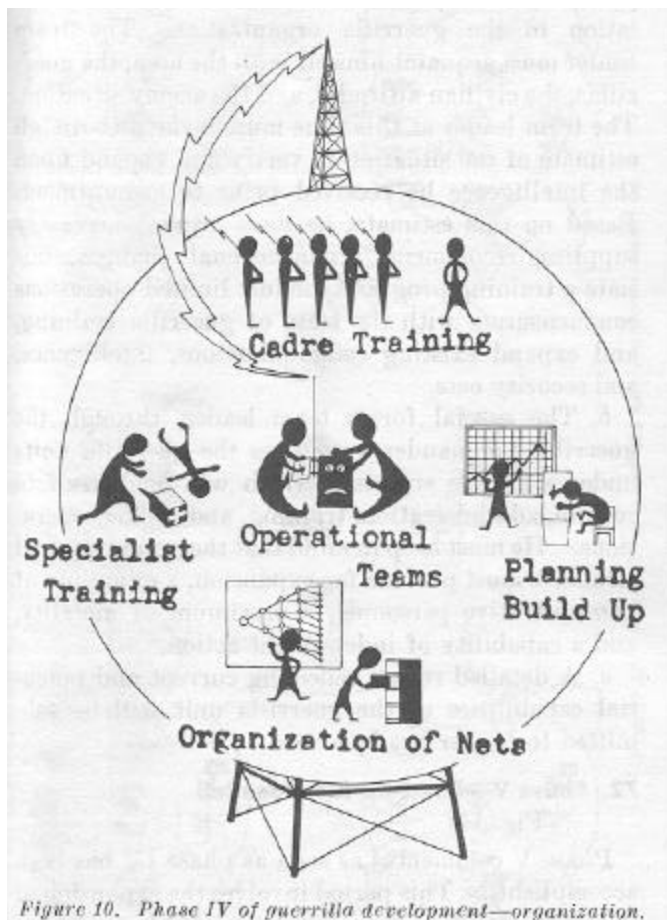

Figure 10. Phase IV of guerrilla development—organization.

relation to the guerrilla organization. The team leader must acquaint himself with the area, the guerrillas, the civilian attitudes, and the enemy situation. The team leader at this time must make a thorough estimate of the situation to verify and expand upon the intelligence he received prior to commitment. Based on this estimate, he must request necessary supplies, recommend organizational changes, initiate a training program, conduct limited operations commensurate with the state of guerrilla training, and expand existing communications, intelligence, and security nets.

b. The special forces team leader, through the guerrilla commander, organizes the guerrilla units under a flexible structure which will lend itself to control, administration, training, and combat operations. He must keep in mind that the organizational structure must provide for expansion, a minimum of administrative personnel, a maximum of mobility, and a capability of independent action.

c. A detailed report reflecting current and potential capabilities of the guerrilla unit will be submitted to higher headquarters.

72. Phase V. —Build-Up (Confidential)

(Fig. 11)

Phase V commences as soon as, phase IV has been accomplished. This period involves the expansion of the organization. Communications and special intelligence nets are further developed, the basic training program of the guerrillas is stepped up, and limited supply stocks are maintained.

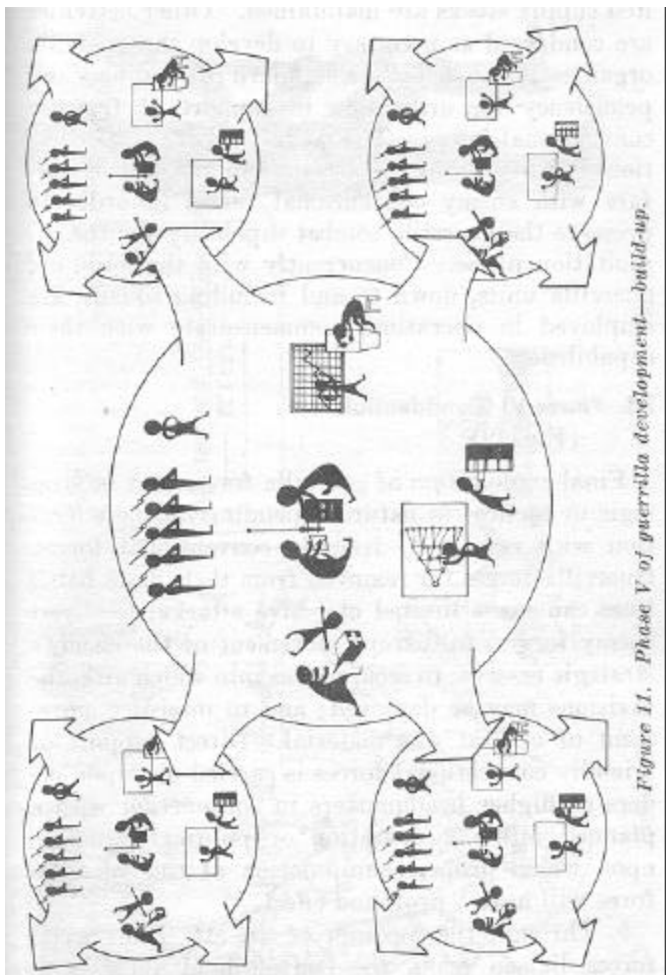

Figure 11. Phase V of guerrilla development—build-up.

Other, activities are conducted as necessary to develop the guerrilla organizations to a proper standard of readiness and proficiency for utilization in support of friendly conventional forces. The magnitude of these operations is governed by the necessity to avoid open warfare with enemy conventional force in order to preserve the guerrilla combat capability for the exploitation phase. Concurrently with the build-up; guerrilla units, down to and including squads, are employed in operations commensurate with their capabilities.

73. Phase VI (Confidential)

(Fig. 12)

a. Final exploitation of guerrilla forces may be strategic or tactical in nature depending on their location with respect to friendly conventional forces. Guerrilla forces far removed from their main battle lines can make limited objective attacks, to divert enemy forces; to disrupt movement of the enemy's strategic reserve; to secure areas into which airborne divisions may be deployed; and to interdict movement of critical war material. Direct support of friendly conventional forces is carried out upon orders of higher headquarters in conjunction with a planned military operation or political situation upon which proper manipulation of the guerrilla force will have a profound effect.

b. Through the medium of an attached special forces liaison team, the conventional force commander may be directed to—

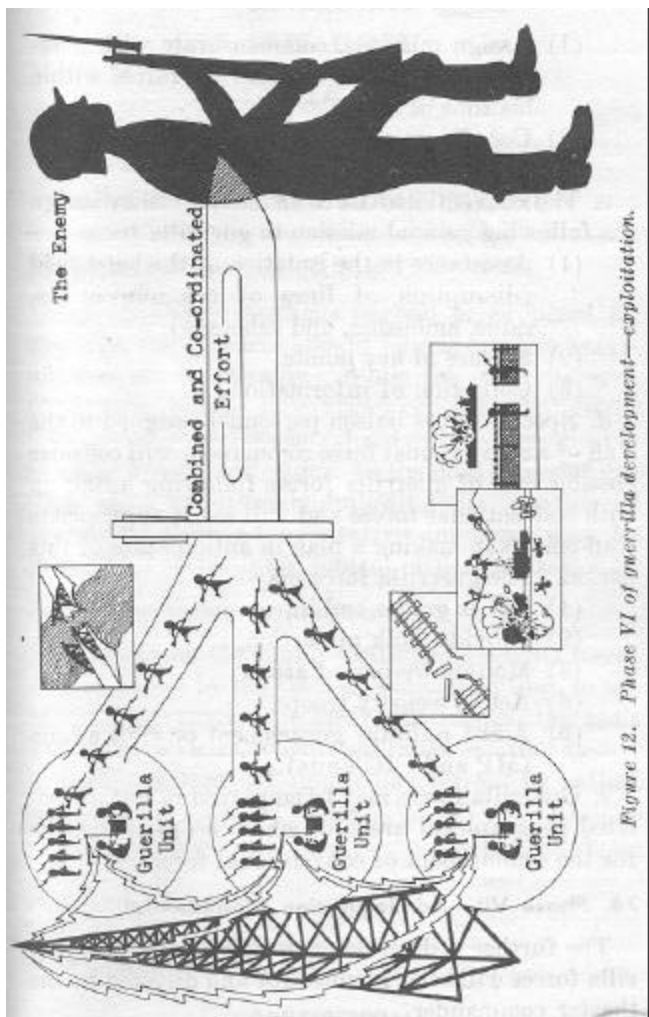

Figure 12. Phase VI of guerrilla development—exploitation.

(1) Assign missions, commensurate with guerrilla capabilities, to guerrilla forces within his zone of action.

(2) Coordinate activities of guerrilla forces adjacent to his zone of action.

c. The conventional force commander may assign the following general mission to guerrilla forces

(1) Assistance in the isolation of the battlefield (disruption of lines of communications, raids, ambushes, and sabotage).

(2) Seizure of key points.

(3) Collection of information.

d. Special forces liaison personnel assigned to the staff of a conventional force commander will consider possible uses of guerrilla forces following a link-up with conventional forces and will assist appropriate staff officers in making a plan in anticipation of this period. The guerrilla force may

(1) Act as guides and interpreters.

(2) Provide flank protection.

(3) Mop-up by-passed areas.

(4) Act as security troops.

(5) Assist military government or civil affairs (MP and CIC units).

e. Guerrilla forces may be employed in certain isolated geographical areas in which no plan is made for the commitment of conventional forces.

74. Phase VII—Administration (Confidential)

a. The further utilization or demobilization of guerrilla forces will be as planned for and directed by the theater commander.

PART THREE

GUERRILLA FORCES

CHAPTER 12

GUERRILLA FORCE ADMINISTRATION

75. Responsibility (Unclassified)

Administrative methods devised or proposed by guerrilla commanders should be respected to maximum extent practicable. While the guerrilla area commander retains supervisory control, administrative operations are decentralized so far as practicable to subordinate commands. In the final stages of operations or immediately following the cessation of hostilities, these administrative functions may be centralized to facilitate control or demobilization.

76. Theater Guidance (Unclassified)

Guidance for the administration of guerrilla forces will be issued by the theater commander and, to the extent the situation permits, will furnish the basis for broad policies, when applicable, relating to—

- a.* Recognition of guerrilla forces by allied powers.
- b.* Promotions.
- c.* Records.
- d.* Decorations.
- e.* Pay.
- f.* Demobilization.

CHAPTER 13

GUERRILLA FORCE INTELLIGENCE

Section I. INTRODUCTIONS

77. General (Unclassified)

Knowledge of the enemy, the terrain, and the weather within a guerrilla area command is essential for successful plans and operations of a guerrilla force. Timeliness is a critical factor in producing and disseminating intelligence. Due to the nature of guerrilla operations, a large percentage of guerrilla intelligence is obtained through clandestine methods (app. III).

78. Mission (Unclassified)

The mission of the guerrilla intelligence organization is to provide intelligence for the commander and to neutralize the effectiveness of the enemy intelligence system within the operational area. Tactical and strategic intelligence missions may be assigned to guerrilla forces.

Section II. GUERRILLA INTELLIGENCE

79. Organization (Unclassified)

During the initial phase of the organization of a guerrilla command, the intelligence section of the staff is given special emphasis. Throughout all phases, the intelligence net is expanded progressively until the

intelligence requirements for the guerrilla area command headquarters and for higher headquarters can be fulfilled. Although supervised by the guerrilla area command intelligence section, the collection of information is decentralized, as far as practicable, to subordinate commands.

80. Requirements (Unclassified)

a. A guerrilla command must produce the intelligence needed for its own security and for local plans and operations against the enemy, as well as accomplish other intelligence missions when assigned by higher headquarters.

b. Thorough knowledge of the terrain, and of the enemy forces is a prerequisite for the successful organization and exploitation of a guerrilla force. The term "enemy forces" includes all antiresistance organizations as well as armed forces. Detailed current intelligence includes enemy strength, dispositions, movements, armament, supply, and habits. To assist the guerrilla force in maintaining support from the population, current intelligence must cover the enemy's political, economic, administrative, and propaganda policies and measures.,

c. Covert or overt operations against the enemy require intelligence that covers specific objectives in minute detail. Intelligence may include

- (1) Detailed study of the topography surrounding and within the objective area.
- (2) Enemy strength, equipment, location, disposition, organization, and movements.

- (3) Enemy reinforcements within supporting distance.
- (4) Communications.
- (5) Details on defense to include guards, alarms, and obstacles.
- (6) The actions and habits of the forces.
- (7) Civilian activities within and around the objective area.
- (8) Psychological warfare vulnerabilities of enemy troops and/or the civilian population; evaluation of current friendly psychological warfare campaigns.

d. Guerrilla forces may, be required to collect acid forward or to assist G2 intelligence units in the collection of any or all of the following types of information

- (1) Ground forces.
- (2) Naval forces and commercial shipping.
- (3) Air forces.
- (4) Defenses (air, sea, land), to include passive measures employed.
- (5) Guided missile; and atomic weapon units.
- (6) Enemy intelligence and counterintelligence.
- (7) Scientific and technical developments.
- (8) Political, economic, and manpower situations in the objective area.
- (9) Topography.
- (10) Location of and conditions in enemy prisoner of war camps.
- (11) Location, activities, and loyalty of certain important civilians.

81. Collection of Information (Unclassified)

a. General.

- (1) The requirements of the guerrilla command and the intelligence missions assigned by higher headquarters, when required, form the basis of the intelligence plan. The preparation of an intelligence plan is an essential step in determining the organization and development of guerrilla collecting agencies and in coordinating the efforts of all guerrilla echelons. The assignment of tasks to agencies that function directly under the guerrilla command is based upon the availability and suitability of the collecting agency to accomplish the mission. The completed plan forms the basis for orders governing the organization, of agencies, for the search for information, and for requests to the next higher commander for ,additional personnel and equipment.
- (2) Organized forces within the guerrilla command are charged with intelligence responsibilities. In addition, clandestine nets of agents and informants who have limited contact with the guerrillas and little or, no knowledge of the disposition, of guerrilla units and installations can furnish vital information. These agents maintain their civilian status and operate under the cover of normal civilian activities (fig: 13).

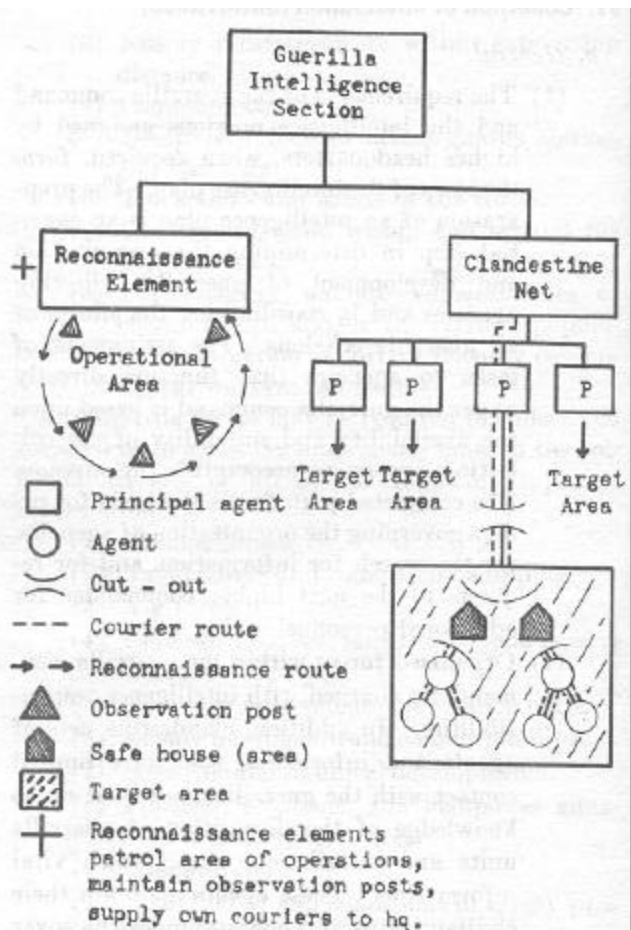

Figure 13. Typical guerilla intelligence net.

b. Special Sources. To collect information of certain types, special sources are organized, operated, and furnished with adequate communications. Such sources may include

- (1) *Air warning stations* along principal enemy air routes in the area. In operational situations, they flash immediate reports of air movements by radio to the guerrilla headquarters. In nonoperational situations, tabular records are kept and submitted periodically.
- (2) *Airfield-watcher stations* in the vicinity of operational airfields. Information regarding the numbers and types of planes and each field and landings and takeoffs is furnished by flash radio or periodic reports.
- (3) *Coast-watcher stations* at points along the coast near the principal enemy shipping lanes. Information regarding enemy sea movements is provided by flash radio or periodic report.
- (4) *Port-watcher stations* in, the vicinity of ports and harbors in use by the enemy. Information regarding types and numbers of ships present and ship arrivals and departures is furnished by radio or periodic reports.
- (5) *Railroad-watcher stations* at points along the principal railroads. Information regarding the movement of supplies and personnel, by rail is provided by flash radio or periodic report.

- (6) *Highway-watcher stations* at points along the highways. Information regarding the movement of supplies and personnel by truck convoy is provided by flash radio or periodic report.
- (7) *Weather stations* distributed throughout the area furnish regular radio reports regarding local meteorological conditions. These reports are consolidated lay the guerrilla headquarters and radioed to the head quarters requesting this information.

c. Prisoners. Skillful interrogation of prisoners taken by guerrilla forces provides an important source of information. When very important prisoners are taken, they should be evacuated to an area controlled by friendly military forces.

d. Captured Equipment. New types of equipment may be captured by guerrillas. The equipment itself or a written description, drawing, or photograph of such material has intelligence value and is forwarded to higher headquarters.

e. Captured or Stolen Documents and Maps. Guerrilla intelligence agents take advantage of every opportunity to capture or steal enemy documents and maps. These documents are forwarded to the guerrilla command intelligence section for study and further disposition.

82. Processing Information (Unclassified)

Information is processed according to the principles set forth in FM 30-6 (when published). Check DA Pamphlet 310-3 for availability.

Section III. COUNTERINTELLIGENCE

83. General (Unclassified)

Control of counterintelligence, like intelligence, is centralized in the guerrilla command intelligence section with the operations decentralized as far as practicable to subordinate commands. Counterintelligence measures and policies are thoroughly coordinated with all staff sections. Counterintelligence measures are executed by counterintelligence personnel, special agents, informants, special security forces, and troop units.

84. Security of Information (Unclassified)

a. Safeguarding Plans and Records.

- (1) Information is limited to those who need to have it. Each person is given only the information needed to accomplish his mission. Special efforts are made to restrict the amount of information given to individuals who often are exposed to capture by the enemy.
- (2) Administrative records of a guerrilla force, if captured by the enemy, are sources of valuable information that may result in reprisals, not only against the families and relatives of the guerrillas, but against the supporting population to include entire civilian communities.

b. Installations. All installations are located in isolated areas, are kept mobile, and are surrounded by guard and warning systems. Alternate locations

are prepared in advance so that any installation threatened by enemy action can be quickly evacuated to a safer area: Information as to the strength, location, disposition, and type of each installation is limited to personnel who actually, man or have direct dealings with that installation. In general, members of lower units in the chain of command do not know the location of the next higher units. The application of this principle throughout the structure of a guerrilla organization safeguards the security of the organization and limits the information that may be extracted from any individual captured by the enemy.

c. Security Discipline. Security discipline must be strict. All personnel are instructed in security measures. They are impressed with the importance of not divulging operations or dispositions to civilians or any unidentified person. Individuals seeking such information are apprehended or reported to the proper authority. All personnel are instructed that, if captured, they must not give the enemy information regarding their unit or their comrades and they are warned that if they give information to the enemy, regardless of the circumstances, they will be regarded as traitors and punished accordingly. When important members of the unit have been captured by the enemy, efforts are made to rescue the personnel or to prevent them from divulging information.

d. Training and Briefing. The principle of restricting the information concerning the location

of headquarters and installations is observed in training.

e. Communications. The guerrilla commander prescribes standing security procedures for all means of guerrilla communications. These measures include restriction on what may be transmitted, the use of codes, radio procedures for concealment and deception, and authentication.

f. Civilian Population. The guerrilla commander prescribes procedures for the control of the civilian population in guerrilla-controlled areas. These measures may include screening the population to discover collaborationists and espionage suspects, placing restrictions on civilian travel and communications, and removing civilians from the vicinity of various installations. All civilians are made to understand clearly that giving information to the enemy regarding the guerrilla forces or their activities, regardless of the circumstances, will result in severe punishment. Civilians are advised not to acquire unnecessary information regarding the guerrilla forces so that they can give little information of value if interrogated. Responsible civilian leaders are instructed to hide or evacuate poor security risks and families of known guerrillas when enemy forces are active in the area.

g. Counterespionage. The guerrilla commander prescribes the procedure and coordinates action to detect and apprehend spies, informers, and collaborators. Town and village, leaders or mayors are held strictly accountable for reporting the arrival and departure of nonresident personnel. Within

controlled areas, strangers and other suspects are arrested and investigated. Normally, local civilians loyal to the resistance movement play a major role in the detection and apprehension of enemy agents.

h. Physical Security. Every effort is made to prevent the enemy from gaining information regarding the guerrilla area. Road signs and mileposts may be destroyed or placed at other points. Bridges leading into the interior may be destroyed. Guides forced to accompany enemy patrols attempt to lead them by circuitous and difficult routes. New trails concealed from aerial observation are constructed for guerrilla use.

CHAPTER 14

GUERRILLA FORCE OPERATIONS

Section I. ORGANIZATION AND TRAINING

85. General (Unclassified)

a. Guerrilla units, so far as possible and practical, should parallel conventional military units in organization and the employment of tactics and weapons. Within the guerrilla unit, regardless of size, requirements exist for mobility, tactical balance, flexibility, fire power, and fire support. Arbitrary organization along conventional lines is not the solution. Adherence to conventional principles of organization, modified to meet the needs of a particular area, will provide the guerrilla commander with a balanced unit he can easily control.

b. Organization of a guerrilla force must be carefully planned in the early stages of its development. This is essential to—

- (1) Establish a basis for planning requirements of logistical support and combat support to be furnished by special forces.
- (2) Determine requirements for training, discipline, and cooperation with other guerrilla units.

c. Areas of operation must be organized to insure coordination of tactical operations. Normally these areas are established by use of geographic

boundaries, such as mountain ranges and river lines. These areas are established into districts and area commands for coordination at higher levels.

86. Training (Unclassified)

a. Successful operations with a minimum loss of guerrilla, personnel necessitate a sound individual and unit training program.

b. Based on the training directives issued by the guerrilla commander, the training program is implemented by subordinate commands. Whenever possible, individuals should receive training in camps or installations in safe areas. Technical training or special training is accomplished by dispatching training teams to the lower units. A situation may require that some personnel be withdrawn from the area of operations for training within friendly lines. Limited facilities may require the establishment of central schools or training centers. Special teams or training centers will be required to instruct—

- (1) Communications personnel.
- (2) Demolitions personnel.
- (3) Ordnance personnel.
- (4) Medical personnel.
- (5) Intelligence agents.
- (6) Staff personnel.

c. The individual guerrilla is trained by his unit in—

- (1) Security procedures.
- (2) Tactical operations.
- (3) Camouflage and concealment.
- (4) First aid.

- (5) Map reading.
- (6) Demolitions.
- (7) Weapons.
- (8) Basic communications.

Section II. MARCHES AND MOVEMENT

87. General (Unclassified)

Guerrilla. units, in order to maintain mobility and conduct operations, must be capable of moving long distances with little or no warning. Normally, a guerrilla unit moves in small detachments on foot. All march movements must be protected by security elements. The move should be carefully planned prior to its execution, with emphasis on a simple march order and on the maintenance of march discipline.

88. Preparation for March (Unclassified)

Preparations for the movement of a guerrilla unit include—

- a. Selection of the route.
- b. Selection of immediate assembly areas.
- c. Order of march.
- d. Inspection of personnel and animals.
- e. Arrangement for the transport of wounded personnel.
- f. Selection of final assembly and dispersal areas.
- g. Reassembly plans in event that surprise attacks necessitate dispersal.

89. Marches (Unclassified)

The night march is the normal method of Movement made by guerrilla forces. Orders issued should include the following information for both night and day marches—

- a.* Location of enemy installations.
- b.* Designated route and march objective.
- c.* Order of march.
- d.* Disposition .of security elements.
- e.* Intermediate assembly areas.
- f.* Recognition procedures.
- g.* Provision for movement of wounded personnel.

Section III. SECURITY MEASURES

90. Responsibility (Unclassified)

a. The guerrilla commander is responsible for all security measures for protecting his command. He coordinates these measures with his subordinate commanders.

b. Security measures prescribed by the guerrilla commander are affected by the following factors—

- (1) Mission of the command.
- (2) Situations of individual units.
- (3) Topography.
- (4) The enemy situation.
- (5) The capabilities and limitations of the guerrilla forces.
- (6) Relations with civilian population.
- (7) Operations of allied conventional forces.

91. Dispersion (Unclassified)

a. Large concentrations of troops in either camp or bivouac are avoided. Even though tactical or logistical conditions permit large troop concentrations, commands should be broken up in platoon areas and widely dispersed. Dispersion facilitates concealment, mobility, and secrecy. Large forces may be concentrated to perform specific operations. On completing the operation, the force should be dispersed quickly into small units.

b. Knowledge of the, location of each unit is restricted to the members of the unit and to the specific personnel authorized to deal with the unit. Only those members of a platoon who need to know the location of their company headquarters or the location of the other platoons should have such knowledge. The application of this principle throughout the structure of a guerrilla organization limits the amount of information that may be extracted by the enemy from captured guerrillas.

c. The principles of dispersion are applied to command, service, and technical installations. Large guerrilla area command headquarters, for example, are divided into several echelons and dispersed.

d. In the event of a well conducted, large-scale enemy operation against the guerrilla forces, the guerrilla commander may find it necessary to divide the units into small groups and instruct them to disperse until the enemy action is over or to infiltrate into another area. This action should be taken only as a last resort as it means that the force

will become inoperative for a considerable period of time and morale of the unit adversely affected. Reassembly points are designated before the groups disperse. To be certain that the assembly points are not compromised, the units are warned to be cautious in approaching these points.

92. Mobility (Unclassified)

All guerrilla installations and forces must have a high degree of cross-country nobility. Equipment that must be moved should be capable of disassembly into one-man loads. Alert and evacuation plans for installations and units must provide for the caching or destruction of supplies and equipment that would reduce mobility. Although pack animals or other transport may be used under certain conditions, alternate plans should include movement without these facilities.

93. Dispositions (Unclassified)

Troops and installations within a guerrilla controlled area are disposed to strengthen the security of the command as a whole. Special consideration is given to the location of command and communication installations and the relative location of lower units. An enemy force penetrating the guerrilla-controlled area in the direction of the guerrilla headquarters should first pass through the sectors of several lower units:

94. Security Nets (Unclassified)

The primary purpose of security nets is to provide the guerrilla commander timely warning of pending

enemy action. These nets may parallel the intelligence collection efforts to confirm the validity' of warning reports. These nets do not obviate the necessity for local security. Security nets will extend well beyond the immediate operations area. Information submitted by agents covers—

a. Time and place leading elements of the enemy force were observed and direction of movement.

b. Size of the enemy force.

c. Enemy arms and equipment.

d. Enemy activities, such as questioning civilians, commandeering guides, etc.

e. Information possessed by enemy; presence of informers, captured guerrillas, and civilian hostages.

95. Reaction to Enemy Operations (Unclassified)

Inexperienced guerrilla commanders and troops are often inclined to move too soon and too frequently to escape enemy troops conducting antiguerrilla operations. Unnecessary movement caused by the presence of the enemy may expose guerrillas to greater risks than if they remain calm and concealed. Unnecessary movement also disrupts routine work, security, and supply arrangements, and exposes guerrillas to possible agents and informers who may be collaborating with the enemy.

Section IV. OFFENSIVE OPERATIONS

96. General (Unclassified)

a. Guerrilla offensive operations are primarily conducted against enemy lines of communications.

These operations should be planned and executed to be continuous throughout the area of operations.

b. Guerrilla forces normally operate in small units. They constantly maneuver behind the enemy lines. Units move separately, reassemble quickly, and attack the enemy along his lines of communications. After they have completed an attack, the forces withdraw along previously selected routes or disperse to assemble at an established rendezvous.

c. Guerrilla forces normally attack a target with superior force. However the element of surprise will often allow guerrillas to successfully attack a numerically superior force. Attacks are executed at unexpected times and places to enable guerrilla units to capitalize on the element of surprise and the resulting confusion.

d. A guerrilla unit's light weapons and equipment permit it to maintain flexibility of maneuver.

e. Guerrilla operations are offensive in nature. A guerrilla force must initiate action, choosing its own time and place for attack.

97. Raids (Unclassified)

A raid involves a movement into enemy-controlled territory and is characterized by surprise, shock action, and a rapid withdrawal after attack. Raids are conducted against semi-permanent targets. In addition to demoralizing enemy forces, raids may have one or more of the following purposes

- a.* To destroy a vital installation.
- b.* To capture prisoners or supplies.

- c.* To divert attention from another operation.
- d.* To cause maximum deployment of enemy troops.

98. Reconnaissance for Raid (Unclassified)

Raids are preceded by extensive intelligence and reconnaissance of the target. Secrecy is observed to prevent the enemy from being forewarned of guerrilla intentions. Detailed information is obtained regarding—

- a.* Approach and withdrawal routes.
- b.* Loyalty of the civilian population in the area.
- c.* Physical layout of the installation.
- d.* Security and guard system of the target, including the communications system.
- e.* Defense system of the installation, including location of key defense points.
- f.* Attitude, state of training, and morale of defenders.
- g.* Location of enemy forces capable of both immediate and later intervention.

99. Planning and Rehearsal for Raid (Unclassified)

a. A detailed plan is prepared and issued to participating units. The plan must be simple and must not depend on too many contingencies for its success. Alternate arrangements are made for the execution of key operations.

b. Time and space factors are considered carefully, and adequate time is allowed for assembly and movement. The requirements of the situation determine whether movement and attack should be made during daylight or darkness. Darkness is favored when the operation is simple and the layout of the

installation is well known. Early dawn or daylight is favored when imperfect knowledge of the installation or other factors necessitate close control of the operation. A withdrawal late in the day or at night makes close pursuit by the enemy more difficult.

c. All participating units are rehearsed in their roles. The necessity for boldness and speed in executing the plan is stressed. Current target intelligence is maintained, and plans are revised as necessary.

100. Organization of Raiding Force (Unclassified)

Normally, the raiding force includes the following elements—

a. The assault element carries out the objective of the raid. Its organization and composition will vary with the objective. This element moves quickly and boldly and accomplishes its mission without unnecessary loss of time.

b. The security element gives warning and prevents the arrival of outside enemy reinforcements. It may execute demolitions or establish ambushes along routes leading to the installation.

c. The reserve element acts as advance guard during the approach. It maintains the line of deployment during the raid, and it acts as rearguard during the withdrawal. It provides fire support for the assault element during the raid, and flank security to protect advance and withdrawal routes.

101. Conduct of Raid (Unclassified)

a. Units to take part in the raid assemble at a previously designated point near the target area for final briefing.

b. The units, preceded by the reserve, advance toward the objective. Agents and guides are contacted along the route of advance and guards are dispatched to the flanks as necessary.

c. On arriving at the line of deployment, the force is met and briefed by the agents who have been observing the installation. Security elements are dispatched. When the situation requires, security elements may be dispatched from the route of advance.

d. The reserve element covers access to the line of deployment, the security element deploys to the flanks, and assault element closes on the target.

e. When the mission has been accomplished, the commander orders the assault element to withdraw, and signals the withdrawal of the security element. After the last assault element has passed over the line of deployment, the reserve element withdraws.

102. Ambushes (Unclassified)

a. The ambush is a method of attack used against rail, motor, troop, and supply movement and closed foot columns. The objective of an ambush may be to—

- (1) Destroy personnel and supplies.
- (2) Harass and demoralize the enemy.
- (3) Delay or block movement of personnel and supplies.

- (4) Canalize enemy movement by making the use of certain routes prohibitive, thus diverting the bulk of enemy movement to major roads, where they will present more lucrative targets for allied air power.

b. The ambush is based on thorough intelligence and detailed planning. Strict security is maintained, and action is characterized by surprise and aggressiveness.

c. Night ambushes offer a wide choice of positions and a good opportunity to surprise and confuse the enemy. Control at night is more difficult than in daylight. Night ambushes are suitable only when the mission can be accomplished during or immediately following the first burst. of fire. The use of the maximum number of automatic weapons at close range is therefore indicated. Daylight ambushes, on the other hand, while giving a more restricted choice of positions, facilitate control and permit offensive action for a longer period of time. Night ambushes may be effective in hindering enemy use of the roads at night, while friendly aircraft attack the roads by day.

103. Planning for Ambush (Unclassified)

a. Plans for an ambush should be based on accurate intelligence covering—

- (1) Enemy strength and dispositions, arms and equipment, communications systems, and habits.
- (2) Habitual or probable movements by the enemy on routes suitable for ambush.

(3) Terrain, to include suitable ambush sites and the best. routes for approach and withdrawal.

b. Intelligence must be backed up by an efficient warning system which will give timely warning of the approach of worthwhile ambush targets, as well as of enemy reinforcements.

104. Movement to Ambush Position (Unclassified)

Forces to participate in an ambush are moved to positions of readiness or assembly areas which are convenient to the ambush site. Guerrillas in the assembly areas receive a final briefing. Movement and noise should be restricted while in the assembly position and at the ambush site. Attention should be given to camouflage and concealment. Civilians inadvertently wandering into the assembly positions should be held until the operation has been completed.

105. Security for Ambushes (Unclassified)

The disposition and size of the security element needed to cover an ambush is governed by the terrain, the capabilities of the enemy, the likely routes that he may use, the mission, the nature of the operations, and the size of the force carrying out the ambush. As a general rule, the longer the main ambushing force is required to remain in position after opening the attack, the stronger the security forces must be. For planning purposes, one third to one half of the overall force is allocated for security details.

106. Selection of Ambush Position (Unclassified)

(Fig. 14)

a. Ambush sites should be selected so that maximum advantages are given to the guerrilla force. When possible, the terrain at the site should canalize the enemy force into the killing zone. Natural obstacles such as defiles, swamps, and cliffs will prevent the enemy forces from taking cover and also prevent them from enveloping the guerrilla forces. When natural obstacles are nonexistent, attention should be given to the use of antipersonnel mines and vehicle mines to canalize the enemy force. Maximum surprise can be achieved by use of less obvious sites, since maximum security measures by the enemy may be expected in the vicinity of favorable sites. The skillful use of mines, demolitions, and air power produce conditions favorable for ambush at points where the enemy is likely to feel secure and therefore less vigilant. No possibility should be overlooked in this type of warfare.

b. The ambush site should have good firing positions which offer concealment and favorable fields of fire. When possible, firing should be made through a screen of foliage. Care must be taken to insure that the entire killing zone within the site is covered completely to avoid dead space that would allow the enemy to organize resistance.

c. The selected site should have approach and withdrawal routes that offer both cover and concealment.

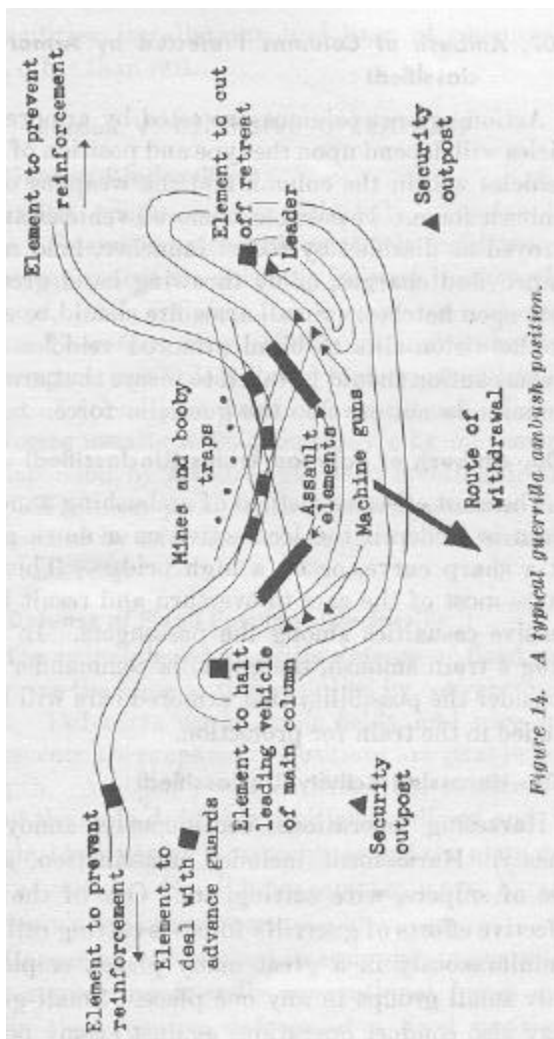

Figure 14. A typical guerrilla ambush position.

107. Ambush of Columns Protected by Armor (Unclassified)

Action against columns protected by armored vehicles will depend upon the type and position of these vehicles within the column and the weapons of the ambush force. If possible, armored vehicles are destroyed or disabled by rocket launcher, land mines, improvised charges, or by throwing hand grenades into open hatches. Small arms fire should be aimed at the vision slits to blind armored vehicles. Extreme caution should be taken to insure that armored vehicles do not envelop the guerrilla force.

108. Ambush of Railroad Trains (Unclassified)

The most effective method of ambushing a moving train is to derail the locomotive on a down grade, at a sharp curve, or on a high bridge. This may cause most of the cars to overturn and result in extensive casualties among the passengers. In planning a train ambush, the guerrilla commander must consider the possibility that armored cars will be included in the train for protection.

109. Harassing Activity (Unclassified)

Harassing operations continuously annoy the enemy. Harassment includes assassination, arson, use of snipers, wire cutting, etc. One of the most effective efforts of guerrilla forces is cutting rail lines simultaneously in a great many places, employing only small groups in any one place. Small groups may also conduct operations against enemy personnel, facilities,

installations, and lines of communication other than rail.

Section V. DEFENSIVE OPERATIONS

110. General (Unclassified)

Guerrilla operations are primarily offensive in nature. Guerrilla units with relatively light weapons and equipment are normally inferior in strength, firepower, and training to enemy conventional forces. Therefore, they should not undertake defensive operations unless forced to do so, or unless in support of friendly conventional operations. Guerrilla forces usually defend themselves by movement and dispersion, by withdrawals, or by creating diversions. Whenever possible, defensive operations are accompanied by offensive actions against the enemy's flanks and rear.

111. Defense of Fixed Positions (Unclassified)

a. The principles of guerrilla defense of fixed positions are the same as those applied by conventional forces. Defensive works, mine fields, and wire entanglements are prepared. Positions are established in depth. Ambush positions should be established beyond the main defensive positions to divert and, if possible, block enemy movement toward the main defensive position: Small units constantly may harass the enemy's flanks and rear.

b. Care must be exercised in assigning to guerrilla forces supporting friendly conventional forces any mission that requires defense of a fixed position.

Supporting fires and counterattacks are not practical in such guerrilla defensive operations. While the enemy forces will have normal logistical support, the guerrilla unit once committed in the defense will have only limited logistical support available. Timing of an operation of this type must be carefully planned and coordinated.

112. Defense Against Encirclement (Unclassified)

a. As encirclement is the greatest threat to the existence of a guerrilla force, the commander is constantly alert for indications of such action by the enemy. Adequate intelligence will give warning of such an attempt. The appearance of enemy forces in two or three directions is regarded with suspicion and is immediately investigated. Upon receiving information that an enemy encircling movement is in progress, the guerrilla commander decides immediately how he will move. He may move toward an unoccupied side of the circle, toward a gap between the encircling units, or toward an area that the enemy will have difficulty in covering during his advance. Secret records and surplus equipment are destroyed or hidden, and movement is begun at once in the desired direction. By this action the guerrilla force either escapes the encirclement or places itself in position to meet it while the enemy lines are still thin and spread out and coordination between advancing units is not well established. When the actual situation cannot be determined, the best action is to move to a ridge line. This gives observation and commanding ground, and allows quick movement in at least two directions.

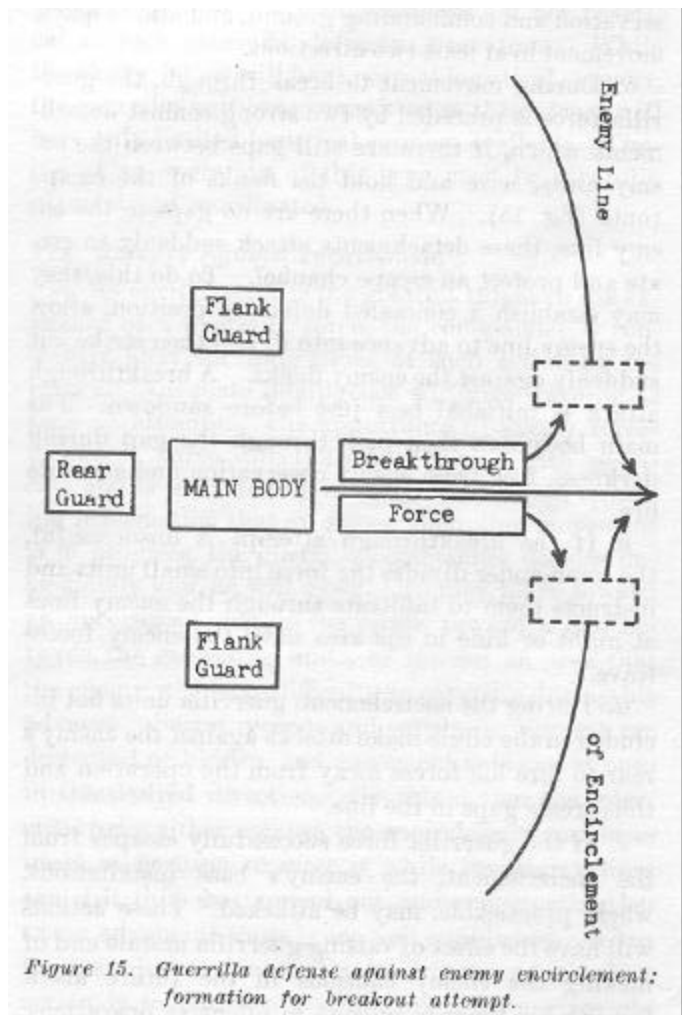

Figure 15. Guerrilla defense against enemy encirclement: formation for breakout attempt.

b. During movement to break through, the guerrilla force is preceded by two strong combat detachments which, if there are still gaps between the enemy units, seize and hold the flanks of the escape route (fig. 15) . When there are no gaps in the enemy line, these detachments attack suddenly to create and protect an escape channel. To do this, they may establish a concealed defensive position, allow the enemy line to advance into it, and then strike out suddenly against the enemy flanks. A breakthrough attack is initiated best just before sundown. The main body can then pass through the gap during darkness, free from enemy observation and accurate fire.

c. If the breakthrough attempt is unsuccessful, the commander divides the force into small units and instructs them to infiltrate through the enemy lines at night or hide in the area until the enemy forces leave.

d. During the encirclement, guerrilla units not included in the circle make attacks against the enemy's rear to lure his forces away from the operation and thus create gaps in the line.

e. If the guerrilla force successfully escapes from the encirclement, the enemy's base installations, where practicable, may be attacked. These actions will have the effect of raising guerrilla morale and of making the enemy cautious in the future about leaving his bases to engage in offensive operations.

CHAPTER 15

GUERRILLA FORCE LOGISTICS

Section I. SUPPLY

113. General (Unclassified)

a. Logistical support of guerrilla forces is essential to successful operations and therefore must be planned for, phased, and executed so as to provide adequate and timely support of guerrilla forces.

b. The type, quantity, and phasing of logistical support influences the organization, capabilities, and limitations of guerrilla forces and the missions that can be assigned to them.

c. External channels of supply should not be established with the forethought that such channels of support will be the only, or principal, source of logistical support. Rather, guerrilla forces should rely on external channels of supply to furnish that logistical support considered necessary but not procurable by guerrilla forces within their area of operations.

d. Guerrilla forces in planning for logistical support should establish adequate support requirements commensurate with projected activities. Once established; these requirements should be reviewed and adjusted, modified, or changed in a manner consistent with confirmed and anticipated operational commitments.

e. The difficulties of supply procurement dictate that rigid supply discipline be enforced. Careful conservation of supplies and equipment must be practiced by all elements of a guerrilla force.

114. Responsibilities (Unclassified)

a. The guerrilla commander delegates supply operations to subordinate commanders but he, retains the responsibility for formulating overall plans and requests for supplies plans and, directives may include—

- (1) Organization of supply and service units.
- (2) Organization and use of civilian units.
- (3) Employment of civilians.
- (4) Systems of levy on civilians.
- (5) Receipt of payment for supplies.
- (6) Collection and distribution of supplies.
- (7) Levels of supplies to be maintained.
- (8) Allocation of supplies to major lower commands.

b. The lower unit commanders are responsible for the supply of their units and for conducting supply operations in accordance with plans, directives and orders of higher headquarters. Normally, supply operations are decentralized and conducted by lower units within their assigned area. For example, if the basic unit is a platoon, the platoon leader is assigned an area from which he locally collects supplies for his unit. The unit commander makes his needs known to the next higher echelon for supplies and equipment not available within his area. He is responsible for the distribution of all supplies and equipment, received from higher headquarters. Besides supplying his

unit, a unit commander may be charged with the responsibility of supplying adjacent units as directed by higher echelon.

115. Organization (Unclassified)

a. Guerrilla organization, scope of operations, and conditions existing within each operational area will determine the logistical organization of guerrilla forces. However; standard military supply procedures can be used as guides in establishing guerrilla supply systems:

b. Guerrilla supply procedures are based on certain essential principles of supply—

- (1) Supply is a command responsibility.
- (2) Supply plans are based on operational requirements.
- (3) Supply plans and systems of supply should be kept simple.
- (4) Distribution plans must be flexible, and supply installations must be mobile.
- (5) Quantities of supply should be adequate but not excessive.
- (6) Captured enemy materiel and local sources of supply are used to the maximum.

116. Receipt System for Payment of Supplies (Unclassified)

The guerrilla commander should be authorized to pay for locally procured supplies by receipt.

117. Levy System of Supply Procurement (Unclassified)

To insure an equitable system of drawing supplies from the population, a methodical levy system is used. It is based upon the ability of each family to contribute. The organization of the civilians under local leaders provides an efficient operating agency. The basic unit commander of each area requisitions the supplies for his unit through the organized civilian unit leaders. Standing operating procedures cover the regular supply of expendable items. Special requisitions are made to procure items such, as clothing, blankets, and medical supplies.

118. Other Sources of Supply (Unclassified)

a. All echelons of a guerrilla force are encouraged to supplement their supply needs at the expense of the enemy. Battlefields anti the scenes of, all encounters with the enemy are combed far usable supplies. Raids are conducted against enemy transport, installations, and supply depots to obtain supplies. Agents and friendly civilians employed by the enemy pilfer enemy stocks whenever the opportunity arises.

b. Where practicable, units may operate shops and factories to produce needed items of equipment. Such activity, however, should not be engaged in at the expense of more important activities of the unit. For instance, guerrilla forced seldom raise their oven food, although they may assist civilians at planting and harvest time.

c. The extent to which guerrilla forces can function when wholly dependent upon local sources for procurement of supplies and equipment varies in great degree. As a general rule, however, the potential of a guerrilla organization cannot be fully exploited without supplies and equipment furnished by external sources. The amount of external support varies from small supply shipments, to total logistical support. Logistical support furnished to guerrilla forces will be commensurate with operational commitments and will be in accordance with theater policies.

d. Personnel, supplies, and equipment will be delivered to a guerrilla force by air, sea, or land. The recommendations of the guerrilla commander and the special forces operational team leader are fully considered before final selection of the means for delivery is made.

119. Caches and Storage (Unclassified)

During the initial phases of a resistance movement the accumulation of supplies and, equipment may be piecemeal. To safeguard this. material against the enemy and to protect it from the elements, caches and storage facilities will be required.

Section II. MEDICAL SERVICE

120. General (Unclassified)

a. The guerrilla commander is responsible for the medical service within his command. The plan for, medical treatment, evacuation; and hospitalization is prepared by the chief surgeon.

b. Prompt and efficient treatment and evacuation of casualties in guerrilla operations is of the utmost importance. However, in some situations it will be impossible to evacuate all casualties and they have to be concealed. The decision to follow such a course of action rests with the senior guerrilla commander present at that time. Such a decision will be made after all reasonable measures for evacuation have been exhausted and maximum available medical aid rendered to the casualties.

c. The execution of the medical plan is decentralized to the individual guerrilla commanders. This is done to allow small unit commanders to meet sudden and unexpected local reverse's. The degree of decentralization is influenced by the following factors—

- (1) Availability of qualified personnel, treatment facilities, transportation, medical supplies, and equipment.
- (2) The enemy situation.
- (3) Medical support from external sources.
- (4) Availability of supply from local sources.
- (5) Existence of secure hospital centers.
- (6) Means of evacuation.

121. Use of Civilian Facilities (Unclassified)

a. Guerrilla forces may utilize existing civilian medical installations. This should be done in extreme emergency or in areas where enemy-control is ineffective. The loyalty of the civilians within the area, particularly those of the medial institution, must be unquestionable.

b. The guerrilla commander's plan may include the establishment of small covert hospital stations attended by loyal personnel. Other personnel from hospitals operating in insecure areas may be used to smuggle needed medical supplies to the guerrillas.

122. Personnel (Unclassified)

Doctors, nurses, and technical personnel are recruited from the local population. Such personnel may be supplemented by trained, personnel supplied by external sources. Additional personnel, recruited locally, are trained to perform non-technical duties.

123. Civilian First-Aid units (Unclassified)

Locally organized civilian first aid units are used to supplement guerrilla medical personnel and units. Civilian units are trained in first aid and establish emergency-aid stations within their communities. These units are incorporated into the medical plan of the guerrilla commanders. Unlike conventional military medical units, these stations are not mobile, do not follow the units supported, and must be prepared to provide care for casualties until such time as they can be moved to suitable accommodations.

124. Medical Supply (Classified)

a. Medical supplies are of great importance in all guerrilla operations. Normally they are scarce and difficult to procure. They are obtained from three principal sources—

- (1) Local improvisations and manufacture.

(2) Enemy sources.

(3) External supply sources.

b. Medical supplies from external sources will not interfere with the shipment of other supplies, as most drugs have little bulk or weight.

125. Guerrilla Medical Unit (Unclassified)

A guerrilla, force requires a medical aid station under the control of competent medical personnel (fig. 16). Such an aid station is capable of fulfilling the needs of three or four 200-man units operating in a given area. It consists of a doctor and several trained assistants who may be augmented by special personnel when the situation demands. It is similar to a standard aid station for a conventional battalion.

126. Hospitals (Unclassified)

a. Guerrilla hospitals will not be elaborately equipped nor manned by highly skilled personnel. X-ray apparatus, pressure sterilizers, and refrigerators for blood banks are immobile and difficult to obtain. Hospitals should have a small, nucleus of highly trained personnel and a large overhead of ordinary personnel for handling the average convalescent patient. Equipment will consist chiefly of dressing material, essential drugs, and those housekeeping items necessary to keep a patient comfortable.

b. Whenever possible, casualties suffering from severe wounds and injuries, such as shot and shell fragment wounds, are treated covertly at civilian institutions until such time as the casualties may be removed to a guerrilla hospital.

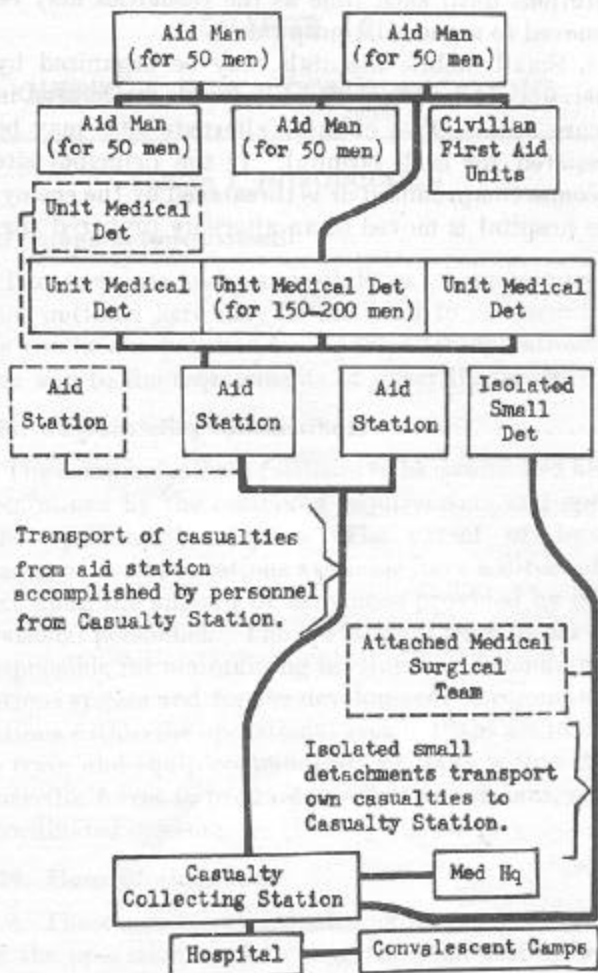

Figure 16. Typical guerrilla medical organization.

~~CONFIDENTIAL~~

c. Small mobile hospitals maybe organized by guerrilla commands. These hospital are located in secure areas. Two or more alternate sites may be prepared for each hospital. If the principal site becomes compromised or is threatened by the enemy, the hospital is moved to an alternate prepared site.

~~CONFIDENTIAL~~

CHAPTER 16

GUERRILLA FORCE COMMUNICATIONS

Section I. INTRODUCTION

127. General (Unclassified)

The doctrines and responsibilities of communications outlined here may be modified to conform to the conditions peculiar to a particular operational area and to the requirements of guerrilla forces.

128. Responsibility (Unclassified)

The communications facilities to be established are determined by the command requirements and specific operational missions. The extent of local means of communications available have a direct effect upon the amount of assistance provided by operational personnel. The operational team leader is responsible for maintaining his link in the communications system and for the development of communications within the operational area. Plans are made to train and equip communications units within the guerrilla forces to produce an effective, efficient, and coordinated system.

129. Plans (Unclassified)

a. The communications plan is an integral part of the operations and intelligence plan established by the operational team leader. During the progressive phases

of organization and as additional requirements are given the guerrilla forces, the communications system is expanded by developing additional facilities or by expanding those used during the initial stages. Intelligence matters and important operational matters have priority on operational area communications systems. Other requirements are serviced when the communications system becomes capable of handling the flow of traffic.

b. The guerrilla commander's detailed plan includes—

- (1) Means by which messages will be transmitted.
- (2) Security measures to be taken by all communications personnel.
- (3) Local communications facilities within the operational area that can be used successfully without major supplementation or reorganization.
- (4) Supply of signal equipment needed for the communications system within all guerrilla units.

130. Personnel (Unclassified)

Specially trained communications personnel are included in operational teams. Members of these teams must be completely familiar with the difficulties of operating within enemy lines. As the need increases, additional personnel may be infiltrated to reinforce or replace the original team members. Technical training within the guerrilla forces is accomplished by sending training teams to the lower units. These teams may be composed of guerrillas who have been trained locally or technical personnel infiltrated from the special

forces base. Radio operators, message center personnel, cryptographic specialists, and special messengers require special training. In selecting individuals to establish and operate the guerrilla communications system, team leaders must bear in mind that the overall guerrilla mission may stand or fall on the effectiveness of the communications system.

131. Guerrilla Signal Staff Section (Unclassified)

The guerrilla commander has a signal officer on his special staff. Special units are assigned to carry out signal functions and operations. The signal staff officer's job includes—

a. Supervising the communications facilities serving the headquarters.

b. Insuring the efficiency and readiness of communications to and within all elements of the operational area.

c. Supervising signal supply and maintenance.

d. Integrating the communications plan with the operations and intelligence plan of the guerrilla units.

e. Training the signal units that provide the communications personnel for the operational area.

Section II. MEANS OF COMMUNICATION

132. General (Unclassified)

The principal means of signal communications employed by operational teams in the operational area and within the guerrilla force are messenger and radio. Other means may include homing pigeons and wire, sound, and visual signals. The messenger system and the radio nets used will vary with the terrain of the operational area, enemy situation, operational requirements, and the means available.

133. Messenger Service (Unclassified)

a. Rugged terrain and enemy-controlled areas that may often separate units will complicate any physical system of communications. A messenger service operating under adverse conditions must be highly organized, flexible, and manned by well-trained, clever, and alert personnel.

b. Courier routes are established to link various commands. At each headquarters through which a courier route passes, a message center is organized. Additional message centers are organized at the junction of main routes. Between message centers and along all courier routes, relay stations are located every four to six hours traveling time. Each message center and, relay station is manned by qualified operating and security personnel.

c. Each message center and relay station has the responsibility to route and carry messages to the next center or station along the designated route. Each message center and relay station is responsible for keeping informed of the enemy situation and activities

within its area. If a part of a courier route becomes compromised, the responsible relay or message center stations, open alternate routes. Besides handling the flow of messages, the courier routes may, serve as arteries over, which personnel and supplies are moved. The personnel and the installations of the message service may operate openly or clandestinely depending upon the enemy situation. Women and children may, be employed extensively, because they are particularly suitable to operate over, parts of the routes that are exposed to enemy vigilance.

134. Radio Communications (Unclassified)

a. Because of its flexibility, radio is the most effective means of communications for use in the operational area. radio equipment should be light but rugged enough to withstand prolonged field use under adverse conditions. It should permit easy movement, preferably a one-man load. It should have long range capabilities employing, radiotelegraphy and wide coverage of the high frequency (HF) portion of the spectrum. It should have an efficient power, unit capable of operation from direct current and alternating current sources of various voltage and, cyclic rates. It should be of straight forward circuit design with a minimum of circuit controls, in order to facilitate, operation and maintenance. Radio equipment fox the internal communications requirements of the guerrilla forces may consist of those types of frequency modulated voice operated

radio sets presently in standard use by conventional forces.

b. Radio equipment for air-ground communications in the operational area must be extremely portable but rugged enough to withstand field conditions. Normally, such communications will be over relatively short distances, utilizing that radio equipment which is standard for Air Force pathfinder, operations. Any long distance air-ground, communications requirements will be met by employing radio sets used in the operational area command net.

c. The radio communications system of a typical operational area normally links the guerrilla headquarters with the operational teams. The initial guerrilla net is established by operational teams. Detailed information on radio nets is contained in appendix IV.

d. Security requirements limit the use of radio. The enemy will monitor all radio transmissions. He obtains information merely by knowing that radios are operating. His analysis of the number of radios in operation, the volume of traffic, or the location of sets is particularly valuable and presents him with information with which he may hamper the activities of guerrilla forces:

e. All personnel using radio communications must understand security measures.

- (1) Physical security includes those measures taken to protect signal equipment and classified documents from capture, damage, or loss. All units operating in, enemy territory will move their radio transmitters frequently to prevent detection or capture.

- (2) Cryptographic security is attained by using technically sound cryptographic systems. Cryptographic operating instructions must be strictly observed to reduce the possibility of the enemy's determining the extent, function, and type of operations. Time spent in encrypting messages gives a high return in security. Commanders must weigh all the facts before they make a decision to send messages in the clear.
- (3) Transmission security, as it pertains to radio, results from all measures designed to protect radio transmission from interception and traffic analysis. Radio transmission is particularly vulnerable to interception, position finding, traffic analysis, and deception. Radio operators must be thoroughly trained in correct procedures to deny information to the enemy through faulty operating procedures or techniques. Additional, information on communications security is contained in AR 380-5 and JANAP 122A.

CHAPTER 17

RESUPPLY OPERATIONS

Section I. AMPHIBIOUS RESUPPLY OPERATIONS

135. General (Unclassified)

a. a. To accept supplies by amphibious means, guerrilla forces must be in control of the reception site. The movement of supplies from an unloading point and subsequent distribution is time-consuming and requires considerable personnel and maximum security.

b. Resupply by submarines encompasses many disadvantages

- (1) The size of the equipment and packages is limited by the dimensions of the submarine hatch.
- (2) Normally a submarine will have to lay some distance off shore to discharge the cargo.
- (3) Submarines cannot operate efficiently in coastal waters where underwater rocks, reefs, shoals, and sand bars dominate the areas.

c. Submarines can be used for evacuation purposes, and they provide a secure means for transferring detailed written reports, sketches, maps, and administrative reports and requests between the guerrilla force and higher headquarters.

136. Requirements for Amphibious Resupply (Unclassified)

a. The senior operational team leader is responsible for compiling and forwarding the required amphibious site information as directed by higher headquarters. In addition to aiding the team leader in his selection of primary and alternate unloading points, this information also will be used as a basis for determining the action taken by higher headquarters.

b. Specific information that can be collected includes

- (1) Hydrographic conditions.
- (2) Offshore obstacles.
- (3) Beach description.

c. In compliance with instructions from higher headquarters, the senior operational team leader designates primary and alternate unloading points for amphibious shipments. Higher headquarters communicates advance instructions to the senior operational team leader covering—

- (1) Confirmation of the primary and alternate unloading points.
- (2) Expected time of arrival of the cargo vessel.
- (3) Recognition and all-clear signals to be displayed.
- (4) Communications instructions.
- (5) General nature and tonnage of cargo to be discharged.
- (6) Personnel to be disembarked.

- (7) Liaison instructions.
- (8) Instructions covering evacuation of personnel.

137. Plans and Orders for Reception (Unclassified)

a. The senior operational team leader acknowledges all instructions received relative to the resupply operation. He prepares directives and issues orders to lower echelons for the reception.

b. Before the expected time of arrival, the areas surrounding the designated unloading points, both primary and alternate, are placed under close surveillance to detect any unusual enemy activities. Units located in or near these areas are ordered to remain inactive to avoid attracting enemy attention. Plans are prepared and orders issued for—

- (1) Movement of troops and carriers into the area and for their administration.
- (2) Security measures to be used.
- (3) Details of ship-to-shore unloading.
- (4) Organization of transporting parties.
- (5) Routes and alternate routes over which Supplies are to be moved..
- (6) Points of transfer of loads to relieve carrying-parties.
- (7) Breakdown and distribution of supplies.
- (8) Establishment and operation of special communications facilities.
- (9) Location and organization of the command post controlling the operation.

138. Conduct of Reception Operation (Unclassified)

In the organization of the reception committee, the number of personnel to be mustered will depend on both the amount of supplies being delivered and the nature and distance of the withdrawal routes from the unloading point to distribution points. The reception committee will include a command element consisting of the reception commander and medical and communications personnel. Other personnel required at the unloading point are security troops and personnel to perform unloading duties. Along the routes of withdrawal prepared distribution points will be established. The individual responsible for, receiving the supplies at distribution points will be responsible for movement of supplies to guerrilla units. Breakdown of supplies to subordinate units will be based on the advice; of the operational team leader and the desires of the guerrilla force commander.

Section II. AIR RESUPPLY OPERATIONS

139. General (Unclassified)

a. Air transport is the most practical, flexible, and efficient method to support guerrilla forces.

b. Delivery of supplies, equipment, and personnel by air transport offers many advantages—

- (1) Large quantities of supplies and equipment may be delivered within a short period of time.

- (2) Personnel and material may be parachuted into drop zones or landed by powered aircraft on prepared fields.
 - (3) Delivery and distribution can be facilitated by dropping or landing the loads in the immediate operational area.
- c. The principal disadvantages of air delivery are
- (1) The enemy may locate guerrilla supply points by observation.
 - (2) Weather conditions may make air delivery impossible.
 - (3) The enemy may have air superiority.
 - (4) Supplies may be dropped to the enemy either through operational inaccuracy or enemy deception.

140. Selection of Drop and Landing Zones (Unclassified)

Selection is made from two viewpoints, that of the pilot of the aircraft and that of the reception committee on the ground. The following general requirements are necessary in selecting drop and landing zones

a. The drop zone must be easy to locate by the pilot

b. The drop zone must be free from aerial navigational hazards.

c. For security, the site must be easy to guard by the personnel available for the reception, party. It must not be near towns, villages, and existing airfields.

d. The size of drop zones should be consistent with operational needs.

e. The size and condition of landing zones will be determined by the characteristics of the aircraft employed.

f. Seaplanes may be used to deliver and pick up equipment or, personnel when suitable seacoast areas or lakes are available.

141. Requirements for Air resupply (Unclassified)

a. Before an air operation site is approved for use, it must be cleared as being suitable by the headquarters responsible for furnishing the support.

b. The organization of a reception committee for air operations parallels that for amphibious operations. The leader's duties include selecting a site, reporting the site to headquarters, marking the site, and conducting the reception operation from the ground.

c. Prearranged marking systems will be employed at landing and drop zones.

142. Reception Committee Equipment (Unclassified)

a. Electronic aids employed by the reception committee consists generally of radio aids to air navigation in the form of very high frequency (VHF) homing and marker beacons, and voice operated VHF radio for close-in control of drop zone and air landing operations. For efficient operation, the technique and equipment employed must undergo constant change in order to remain abreast of the latest developments in technique, equipment, and aircraft.

b. Visual aids in the form of panels, lights, infrared devices, and pyrotechnics may be employed for signaling aircraft. Security requirements will normally limit the use of pyrotechnics, except in unusual circumstances. Smoke may be utilized as an emergency signaling method. Lights and infrared devices may be used in marking drop zones and landing strips. Air ground panels may be employed for daytime operations. They can be improvised from any type of material that will be visible from the air. For more detailed information in the employment of visual signals, see FM 21-60.

APPENDIX I

REFERENCES

1. Army Regulations (Unclassified)

- 35 –2015 Entries on Military Pay Records.
- 35 –2035 Payment to Members of the Regular
 Army and Reserve Components
 in Active Military Service.
- 220 –50 Regiment, General Provisions.
- 220-60 Battalion, General Provisions.
- 220-40 Companies, General Provisions.
- 320-1 Dictionary of United States Military
 Terms for Joint Usage.
- 380-5 Safeguarding Security Information.
- 611-103 Officer Qualification and
 Classification.

2. Special Regulations (Unclassified)

- 320-5-1 Dictionary of United States Army
 Terms.
- 320-50-1 Military Terms, Abbreviations, and
 Symbols.
- 335-50-1 Morning Report.
- 380-5-10 Disclosure of Classified Military
 Information to United States
 Nonmilitary Agencies and
 Individuals.
- 380-310-1 Counter Intelligence Corps, Mission
 and Employment.
- 615-20-1 Service Record (Enlisted Personnel).

3. Field Manuals (Unclassified)

- 5-25 Explosives and Demolitions.
- 6-40 Field Artillery Gunnery.
- 6-135 Adjustment of Artillery Fire by the
Combat Soldier.
- 7-10 Rifle Company, Infantry Regiment.
- 7-20 Infantry Battalion.
- 7-30 Service and Medical Companies,
Infantry Regiment.
- 7-40 Infantry Regiment.
- 17-12 Tank Gunnery
- 21-5 Military Training.
- 21-8 Military Training Aids.
- 21-26 Advanced Map and Aerial
Photograph Reading.
- 21-30 Military Symbols.
- 21-60 Visual Signals.
- 21-75 Combat Training of the Individual
Soldier, and Patrolling.
- 22-10 Leadership.
- 24-5 Signal Communications.
- 24-17 Communication . Center Operation.
- 24-18 Field Radio Techniques.
- 24-20 Field Wire Techniques.
- 27-5 United States Army and Navy
Manual of Civil Affairs Military
Government.
- 27-10 Rules of Land Warfare.
- 30-5 (Classified)
- 30-15 Examination of Personnel and
Documents.

30-16	(Classified)
30-19	(Classified)
31-21	(Classified)
33-5	Psychological Warfare Operations.
57-30	Airborne Operations.
100-5	Operations.
100-10	Administration.
100-11	Signal Communications Doctrine.
100-15	Larger Units.
101-1	The G1 Manual.
101-5	Staff Organization and Procedure.
101-10	Organization, Technical and Logistical Data.

4. Technical Manuals (Unclassified)

5-248	Foreign Maps.
30-246	Tactical Interpretation of Air Photos.
57-210	Air Movement of Troops and Equipment.

5. DA Pamphlets (Unclassified)

21-46	Behind Enemy Lines.
30-26	A Guide to the Collection of Technical Intelligence.
108-1	Index of Army Motion Pictures, Television Recordings and Filmstrips.
310-20 series	Publications Indexes.

**6. Allied Communications Publications
(Unclassified)**

- 121 (B)
- 122 (B)
- 124 (A) (Classified)
- 129
- 130 (A)
- 135

**7. Joint Army, Navy, Air Force Publications
(Unclassified)**

- 131 (A)
- 199 (D) (Classified)
- 201 (B)

8. Technical Bulletins (Unclassified)

- SIG 54 Working Through Jamming with
FM Radio Sets.
- SIG 223 Field Expedients for Wire and
Radio.

9. Miscellaneous Publications (Unclassified)

- AM 15 (C) Amphibious Reconnaissance,
United States Marine Corps
Amphibious Manual.
- TOE 10-419 Quartermaster Special Forces
Parachute Rigging Detachment.
- TOE 11-500 Signal Service Organization.(A)
- TOE 33-2 Headquarters and Headquarters
Company, Special Forces Group,
Airborne.
- TOE 33-510 Special Forces Group, Airborne.

~~CONFIDENTIAL~~

APPENDIX II

GLOSSARY

(Confidential)

AGENT—In intelligence usage, one who obtains or assists in obtaining information for intelligence or counterintelligence purposes but who has no apparent connection with any intelligence agency or officer.

CELL—A clandestine unit composed of two or more people and capable of expanding into similar units.

CLANDESTINE NET—Cellular type organization of agents.

COVER STORY—The information, documents, papers, records, references, etc., that identify an agent in his assumed role.

EVASION AND ESCAPE—Comprises the channels and operations whereby United States and allied military personnel and other selected individuals are enabled to emerge from an enemy-held or unfriendly area to areas under allied control.

GUERRILLA WARFARE—Comprises operations conducted generally in enemy-held territory by predominantly indigenous forces organized on a quasi-military or military basis, with or without the support of sponsoring power, for the purpose of reducing the combat effectiveness, logistical support capability, industrial capacity, and

~~CONFIDENTIAL~~

morale of an enemy nation by inflicting damage and casualties.

JOINT SECTOR STAFF—A semi-permanent staff organization from two or more services established for the purpose of prosecuting one or more interrelated fields of unconventional warfare in a designated region(s) of a theater of operations.

JOINT UNCONVENTIONAL WARFARE TASK FORCE—An organization of units from two or more services under a commander at theater level for the purpose of prosecuting one or, more inter-related fields of unconventional warfare. in a theater of operation. See: Unconventional warfare

RESISTANCE—Consists of the subversive, clandestine, and overt operations performed by elements of a population which is hostile to established civil and military authority.

UNCONVENTIONAL WARFARE—Consists. of the inter-related fields of guerrilla warfare, escape and evasion, and subversion against. hostile states.

APPENDIX III

GUERRILLA INTELLIGENCE AGENCIES

1. General (Confidential)

a. The guerrilla's best source of information about the enemy's activities and intentions is not so much from military reconnaissance but a clandestine intelligence network.

b. The success of guerrilla reconnaissance and intelligence, both covert and overt, depends on the—

- (1) Degree to which the guerrillas are familiar with the territory in which they are working.
- (2) Degree to which the guerrillas are supported or aided, actively or passively, by the civilian population.

c. The intelligence organization of a guerrilla unit is the intelligence section of the staff, which consists of two branches—

- (1) The military intelligence branch.
- (2) The clandestine intelligence branch.

d. The staffs of guerrilla units carry out reconnaissance not only for their own benefit, but also in the interest of higher headquarters. They can assist intelligence missions in the military, political, economic, psychological warfare, and counterintelligence fields.

2. Reconnaissance (Confidential)

a. Guerrilla units may have a specially trained reconnaissance unit. Reconnaissance units are composed of the most experienced guerrillas, picked from those who are well acquainted with the topography of the area of operations.

b. Reconnaissance missions are determined by the guerrilla commander in conjunction with the intelligence officer. The leader of the reconnaissance group is given the following information—

- (1) Main purpose of the reconnaissance.
- (2) Detailed tasks of the reconnaissance.
- (3) Time span of the reconnaissance mission: the time of departure and time of return.
- (4) Exact route of march and return and the alternate routes which can be taken in case of contact with a stronger enemy force.
- (5) Time and means for the delivery of information.
- (6) Password and countersign for the whole reconnaissance party during their operation.
- (7) People from the local population whom it is necessary to contact in order to get various kinds of specialized information.
- (8) Knowledge of obstacles and mine fields and passage through them.

c. On return, the leader of the reconnaissance unit makes necessary reports covering the results of the reconnaissance operation.

d. Each reconnaissance leader records the sources of his information: what he himself saw, what he

gathered from the local inhabitants, and what he found out from documents which he secured.

e. The leader of a reconnaissance mission that is carried out for higher headquarters should be oriented toward both tactical and strategic information desired, such as—

- (1) Observation of railroad traffic, to include the type and quantity of troops and equipment being transported.
- (2) Observation of the movement of military formations and motor convoys on the highways.
- (3) Reconnaissance of the enemy's defenses.
- (4) Assessment of civilian reaction to enemy occupation

3. Clandestine Intelligence (Confidential)

a. Guerrilla clandestine intelligence teams are composed of—

- (1) Intelligence specialists who are members of the guerrilla detachment and who are sent out for particular tasks.
- (2) Agents and informants who may live as apparently peaceful citizens in occupied localities.

b. Clandestine intelligence is collected by agents and informants operating within a net. The clandestine net is a cellular type organization performing specific tasks while operating under cover and is characterized by limited communications between cells and individuals within the cells.

4. Recruitment (Confidential)

a. Recruitment of clandestine agents is ordinarily carried out by special agents of the guerrilla intelligence section. Many qualities are desirable in an agent courage, patriotism, personality, character, and education. The person selected as a potential agent must be intelligent in order to carry out his work without attracting attention and must be in a position, or capable of being placed in a position, of supplying needed information.

b. On his own initiative or on order from another agent, the recruiting agent selects a person who might be recruited for intelligence work. The agent gathers all available information about this person, including his biography, information about his connections and acquaintances, his political opinion, relatives, habits, and the type of intelligence or information he can be expected to provide.

c. After the agent has informed himself sufficiently about the person's background, he makes a special report to his superior. If the latter agrees with the choice, the agent begins the actual recruiting. He becomes acquainted with the person and looks for a basis which might be used to induce the person to become an agent. Motivation of the potential agent is an influencing factor in recruitment. Motives are usually one of the following

- (1) *Patriotism*. Love of country and desire for freedom.
- (2) *Ideology*. Ideals corresponding with guerrilla aims and goals.

- (3) *Material gain*. Money, food, goods, etc.
- (4) *Opportunism*. A better position in life or a higher rank in society will fight for side that is winning, or will win in the end.
- (5) *Vanity*. Desire to feel important or desire to be able later to boast of what he has done.
- (6) *Fear*. Fear of reprisals or of possible persecution for being neutral or for being slightly pro-enemy.
- (7) *Jealousy*. Jealous of the respect another receives or envious of not receiving similar respect and glory.
- (8) *Grudge and revenge*. Sense of revenge against the power responsible for action against his family, his country, and himself.
- (9) *Political*. Have ideas conflicting with the political trend of government in power or the invading forces.
- (10) *Profession*. Espionage as an occupation.

d. Patriotism, material gain, and fear are probably the strongest motives of those listed. The fear motive is often used by the guerrilla agent to blackmail recalcitrant persons who occupy positions of access to important information.

e. A casual interview with the potential agent is conducted by one or more selected guerrilla personnel to determine the prospect's desirability for assignment and to learn the potential agent's opinion regarding assignment to the organization. The interview should not be conducted near any guerrilla

establishment, must take place. in an area where people normally are gathered, and must be done in an inconspicuous manner. Only casual reference is made to assignment, and nothing is divulged which could be used later against the organization should the potential agent attempt to inform on the guerrilla forces.

f. If the individual agrees to cooperate, final selection is made by the guerrilla staff and the policy is established regarding any reward or promise that is to be made to the agent in payment for his services. Monetary payment is made on a scale corresponding to the individual's present living or social status, so that he will not suddenly appear to have grown unusually wealthy. Promises may be made concerning payment of sums of money at conclusion of hostilities upon approval of the government in exile. .Other types of promises for payment may be future emigration to another country, or evacuation of the agent's family from a zone of operations.

g. A final interview takes place between guerrilla force representatives and the potential agent at which time agreement is established regarding policy and terms, and a decision is reached concerning the amount and type of training required for the agent prior to undertaking his mission. Throughout the entire recruiting process it is extremely essential that the greatest, amount of security be enforced.

h. The process of recruitment usually should take from one to four months, depending on the investigation necessary and the amount of opposition on the part of the person being recruited.

Once recruited and trained, the new agent is given his place as an operative worker in an intelligence net and instructed as to what information is to be reported and what intelligence channels of communication will be used by him. The new agent is given easy, uncomplicated tasks during the first few months after his recruitment. Often he is asked to supply information which is already known in order to check on his abilities, security, and loyalty.

5. Agent Training (Confidential)

a. Personnel are trained in selected areas where overall security may be insured and where there is little chance of interruption of the training. Training may take place in friendly controlled areas, in enemy occupied zones in sections under guerrilla control, or in areas such as dense forests, swamps, or mountains where the terrain offers some security from enemy interference.

b. Personnel are taught only subjects that are directly concerned with their mission. Training of individuals is carried out with as little contact as possible with other personnel, both other agent trainees and operational personnel. If such contact is necessary, security is maintained through code names allotted to all individuals.

c. The agent is told only the names or code names of the personnel connected directly with his mission, and then only after, he has received his assignment. Constant security is maintained to prevent the infiltration of enemy security personnel and agents.

d. All agents should receive instruction in the following common subjects—

- (1) *Observation and description.* To teach the agent to observe in detail and correctly describe what he has witnessed.
- (2) *Reporting.* To teach the agent basic procedure for returning complete, accurate, detailed, concise reports, and to teach the agent the various channels or lines of communications through which the report might be sent.
- (3) *Sketching.* To teach the agent basic sketching, so that should he be assigned a mission that would require him to return with a sketch of an installation or area, he would be able to do so.
- (4) *Code.* To teach the agent the use, employment, and security of types of codes and ciphers which he may use in reporting information.
- (5) *Follow-up leads.* To instruct the agent in the various, procedures or methods used to follow-up a possible lead, and to teach the agent the traps to avoid should the lead be a decoy established by enemy intelligence agents.
- (6) *Cover Stories.* To teach the agent how to formulate and use a logical cover-story and how to detect flaws in one that an enemy, agent or informer may be using.

- (7) *Documentation*. To instruct the agent in the procurement of documents, the falsifying of documents, and the usage of documents to agree with the cover story.
- (8) *Use of informers*. To train the agent to establish his own informant net, and how properly to employ it. Particular attention is given to the selection of personnel as informers who have placement and access to information desired.
- (9) *Rumors*. To instruct the agent in tracing a rumor to its source in the possibility of obtaining valuable information, and to instruct the agent in the procedure of starting false rumors and their effect on enemy and civilian morale.
- (10) *Surveillance*. To teach the agent how to perform a surveillance, and how to detect one should he come under surveillance by enemy, intelligence personnel.
- (11) *Interrogation*. To teach the agent basic interrogation methods in event that he might be required to interrogate enemy personnel.
- (12) *Enemy security organizations*. To give the agent an overall picture concerning the employment of enemy security organizations in the area where he is to operate, as well as to train him in the techniques that are used by these organizations.
- (13) *Agent's security*. To teach the agent personal and organizational security procedures as they concern him and his organization.

6. Clandestine Nets (Confidential)

a. Trained agents are sent to areas that they know well and where they may live or have lived at one time. If practicable they are furnished the names of suitable net personnel by the intelligence section. If not, they must establish their own nets. Independently and secretly, the agent contacts several people whom he believes would be useful in the establishment, operation, and control of a net. The original agent in terminology becomes the principal agent or the person responsible for the establishment and control of one or more nets. The people he has recruited become agents operating their own nets. These agents in turn contact several people they know to be reliable in order to construct their nets.

b. The agents organize cells of individual informants, each operating independently of the other. Association among cell members is restricted to cell activity. Knowledge of members of other cells is similarly restricted. The cell is the operational part of the net and is the section that actually performs the net's mission.

c. The cell purposely should be as small as possible. This will prevent the destruction of an entire net should one of its members be captured, interrogated, and forced to compromise other known operatives. The number of cells is unlimited; dependent only on availability of personnel, ease or difficulty of control, and scope of operations. However, while the cells of various nets may obtain

information from the same enemy installation, an individual informant may work only one net (fig. 13).

7. Net Communications (Confidential)

a. Communications within the net are almost always through a third person or contact. The means of communications within a net are very limited, and are constantly subject to enemy penetration. In order to protect the agents or the net from compromise, all information concerned with names of agents and installations should be coded.

b. Contacts are used as a means of communication employed between elements of a net and between nets in the following manner—

(1) *Personal contact.* A contact between individual agents at a prearranged rendezvous.

(2) *Letter drops.*

(a) *Live letter drops.* Information is received from an agent, retained by the person operating the letter drop, and is passed onto another agent who calls for it at a prearranged time using a prearranged password.

(b) *Dead letter drops.* Information is left at a predesignated point, unguarded but often under surveillance, by the agent and is later picked up by another agent and forwarded through the net. The agent who deposits the information and the agent retrieving it arrive at the dead letter drop at predesignated times so that they do not meet.

- (3) *Cutouts*. Cutouts are employed to link the activities of two agents who cannot meet without possible compromise.
- (4) *Safe house or safe area*. A safe house is a building (or area) located so as to be safe from immediate intervention and observation by enemy forces. Prior arrangements must be established regarding the use of such houses. In addition to being used as meeting places for control personnel and agents, these houses may also be used to hide wanted personnel who are being evacuated from or through the area.
- (5) *Signals*. Visual signals are employed between agents to assure safe contacts. Any type signal or signaling device may be employed with the use of a prearranged signaling code. Devices such as packages or newspapers carried in a certain manner, coded placement of clothing hanging out to dry, coded display of posters, books or flowers in windows, and coded arrangements of worn clothing are used.

8. Net Security (Confidential)

Net security is based on a system of minimum personal contact between agents. By this system, compromise of the entire net resulting from the arrest and interrogation of individual agents is avoided. Agents and informants operating within nets are given only the necessary details required for them to perform their collection mission and to pass on their information. A constant check is

~~CONFIDENTIAL~~

performed throughout the nets by specially trained counterintelligence agents whose mission is to detect enemy penetration agents, security breaches, and double agents.

~~CONFIDENTIAL~~

APPENDIX IV

COMMUNICATIONS

1. Organization of Communications Nets (Confidential)

a. During the initial stages of operations, the command net may consist of direct communications between operational teams and the base station within friendly lines. When district or area teams are infiltrated, they take over responsibility for the transmission of all operational traffic (except emergency messages) to the base station. All operational teams are authorized direct communication with the base for emergency purposes.

b. The operational net, which supplies the lateral communications required for coordination between operational teams may be initiated immediately after infiltration, or as considered necessary by the local operational team leader. Installation of this net will depend to a great degree on the type of mission assigned and the security requirement of the operational area. Security requirements at times may necessitate the use of messengers as the principal means of communication for the operational net. The radio equipment initially infiltrated with the operational teams for command net use is also satisfactory for operational net communications. A type communications net is shown in figure 17.

~~CONFIDENTIAL~~

~~CONFIDENTIAL~~

2. Frequencies and Call Signs (Unclassified)

Radio frequency coverage, for both transmission and reception, will range between 2 and 16 megacycles. Security requirements necessitate that frequencies be made, available to operational teams in sufficient numbers to permit switching to a new channel after a minimum transmission interval. Transmission time on any one frequency should be limited in order to minimize the possibility of enemy interception and radio position finding. Specific transmission time intervals cannot be stated since this will depend on the enemy capability for electronic countermeasures. Call signs should also be assigned in sufficient numbers to permit changing each time a different frequency is employed.

3. Cryptographic Systems (Confidential)

a. Cryptographic systems employed by operational teams must offer a high degree of security and reliability. The operations of cryptographing and decryptographing must be relatively simple and rapid.

b. Cipher systems such as the "one time pad" method are satisfactory for higher echelon use; that is, from operational teams to the base station. Vocabulary type prearranged code methods that can be changed frequently are more suitable for the forward operational teams: Such methods can be devised to afford a maximum of security consistent with efficient operations and still provide simplicity

in the cryptographing process which is essential for field use.

c. Cryptographic methods for guerrilla forces use are similar; but must be distinct and separate from the systems employed between operational teams. Such methods must be designed for bilingual use in a. particular area of operations in order to permit cyptographed communications between guerrilla and operational , teams. Cryptographic systems of the guerrilla force type can be prepared for interim training purposes utilizing any language or Languages as may be considered desirable: Combination vocabulary numerical cryptographic systems meeting the bilingual requirements of the operational area are suitable for guerrilla force use.

d. Special forces training programs should be conducted to permit complete and thorough understanding by all personnel of the various cryptographic methods employed.

4. Communications Training Requirements (Unclassified)

To accomplish the high degree of efficiency required, communications training must be intensive and deal with certain materials much more extensively than in most army communications training programs: The maximum possible cross-training of communications specialists should be accomplished. Communications personnel should have a thorough knowledge of the following subjects:

a. International Morse code.

b. Radiotelegraph operating signals and procedures:

c. Voice radio operating signals and procedures.

d. Methods of visual signaling and devices.

e. Reception committee radio equipment and procedures.

f. Communications security.

g. Radio jamming techniques and countermeasures.

h. Radio position finding and countermeasures.

i. Basic radio theory.

j. Antennas and radio wave propagation.

k. Radio maintenance and repair (to include third and fourth echelon).

l. Radio field expedients.

5. Radio Equipment (Confidential)

a. The most important requirements for radio sets in the command and operational nets are that they be highly portable and capable of consistent communications over a 24-hour period at those distances that may exist between the operational teams and the base stations. To accomplish the requirements of portability and long distance, compromise must be made in the power output capabilities of the radio transmitter and the type of power generator employed for field operation. To facilitate portability, the transmitter and receiver must be contained in a "one package" or similar arrangement that can be conveniently carried by one man. The radio set and power generator must be designed to withstand air-drop. The transmitter

power output requirement necessitates the use of a gasoline (or other liquid fuel) generator as a power source for field use. Technical requirements for the command and operational net radio set and power generator for field use are as indicated below

(1) *Transmitter.*

Antenna.....Whip, Single wire,
doublet, array.
Frequency.....1.7-15 megacycles.
ModulationsA-3 (amplitude modulation).
Emission.....A-1, (CW) A-3 (phone).
KeyingAutomatic keyer.
Power sourceHand generator, 6 volts
DC (storage battery) 70-
270 VAC; 40-400 CPS.
Power output.....10-100 watts.
Frequency
controlCrystal and VFO
(variable frequency
oscillator).
Weight.....25-30 pounds (including
the receiver).

(2) *Receiver.*

TypeSuperheterodyne.
Antenna.....Same as transmitter.
Frequency
coverage1.7-15 megacycles (con-
tinuous).

Receiver—Continued

Frequency

controlVFO and crystal.

ReceptionA-1 (CW) A-3 (phone).

Power sourceSame as transmitter.

(3) Gasoline power generator.

Power capability ..200-300 watts.

Voltage output110 VAC, 60-100 CPS.

FuelGasoline, or combination
of oil and gasoline.

Weight.....15-20 pounds.

b. At present no radio set is available as an item of standard issue to meet the technical standards indicated in *a* above. The sets available as standard issue for tactical field use by regular forces either lack power output, or the weight factor is prohibitive for operational use. For interim training purposes, a compromise selection may be made from among those sets now available that most nearly meet the technical requirements.

6. Signal Planning (Confidential).

One of the most important considerations in the preparation of signal plans for operations is communications security. A plan of communications must be prepared that will offer maximum security for the operation to be conducted. Provision must be made ,in the signal operation instructions (SOI) for countermeasures to the enemy capabilities for interception, deception, radio jamming, and radio position finding. Special countermeasures will have

to be incorporated in the signal planning depending on the requirements of a particular situation. Countermeasures that must be considered in the signal planning are—

a. Preparation of sound, reliable cryptographic systems, including alternate systems for use in event of compromise.

b. Provision of adequate frequencies (with limited transmission time on any one frequency) to include alternate and emergency frequencies.

c. Provision of radio call signs in sufficient numbers to permit changing with each change in frequency.

d. Provision of adequate radio equipment, to include equipment as required for emergency purposes.

e. Provision for the use of station and message authentication systems.

f. Efficient use of the "blind" broadcast transmission method.

g. Measures to be taken in the event of enemy capture and attempted "playback."

7. Signal Operation Instructions (SOD) (Confidential)

a. Signal operation instructions taken into the operational area by operational teams should be brief, so as to offer a maximum of security and still provide for efficient team communication. Signal operation instructions are prepared in such a manner that, if lost or captured, they will afford the enemy little or no information. The SOI booklet should be

resistant to wear and tear under varying climatic conditions and should be of such a size that it can be easily concealed.

b. Measures taken to insure efficient use of SOI and to provide communication security requirements for operations are—

- (1) Adequate and intensive pre-operational training of all communications personnel.
- (2) Orientation and briefing of communication personnel on the signal requirements.
- (3) Preparation of signal instructions in such a manner as to facilitate commitment to memory.
- (4) Special briefings of communication personnel on last minute changes or revisions to the SOI.

APPENDIX V

GUIDE FOR TRAINING

Section I. GENERAL

1. Purpose and Scope (Unclassified)

This appendix provides a general explanation of the training cycle, for special forces individuals and units.

2. Training Cycle (Unclassified)

The complete cycle of training for special forces personnel is divided into six, phases. Normally, individuals will have completed the basic combat training phase and the basic parachute training phase prior to assignment to a special forces unit. The phases listed are not periods of definite duration, but general periods which blend into one another. Training in some subjects is continuous. Mid, although presented in early phases of training, will recur in subsequent phases. These subjects are indicated in the current army training program for special forces units.

a. Basic Combat Training Phase—8 weeks.

b. Basic Parachute Training Phase—2 weeks, in accordance with current directives.

c. Advanced Individual Training Phase.

(1) Specialist training—8 weeks.

(2) Branch training—8 weeks.

d. Unit Training Phases—13 weeks.

e. Field Exercises and Maneuver. This phase of training will be completed as directed by the parent unit or the Commanding General, Continental Army Command.

f. Preparation for Oversea Movement. This phase will be completed in accordance with AR 614-30.

3. Training Objectives (Unclassified)

a. General. During all phases of training, emphasis will be placed on the development of ability of personnel and units to teach and, instruct indigenous personnel. In addition, all personnel will be given intensive map reading instructions to include working with foreign maps.

b. Advanced Individual Training Phase.

- (1) Specialist training. To qualify the individual to perform the duties required by his table of organization and equipment position.
- (2) Branch training. To provide a knowledge of the organization, functions, and missions of special forces units and the team to which the individual is assigned.

c. Unit Training Phrase. To merge component elements together under team, leadership and develop a unit capable of performing its operational mission, emphasis will be placed on training of operational teams. Unit missions are outlined in section 1, TOE 33-510.

4. Program Organization (Unclassified)

The master schedule, scope of subjects, cadre training program, and recommended training facilities are contained in ATP 33-300.

5. Cadre Requirements (Unclassified)

In a general mobilization, new units are built around cadres. Every unit must so organize and train that it can supply one or more cadres without rendering itself incapable of operation. The training of extra cadres provides a commander with replacement personnel to keep his unit in operation after losses. Unit commanders should designate cadre personnel not to exceed 17 percent of authorized strength. Cadre personnel should be selected and trained in their specialties as early as possible.

6. Assignment of Personnel (Unclassified)

Because special forces operations require a variety of skills, maximum advantage should be taken of previous military and/or civilian experience.

7. Weapons Training (Unclassified)

Qualification and familiarization firing of weapons will be conducted in accordance with AR 370-5.

8. Problems and Exercises During Unit Training, (Unclassified)

a. The period of unit training time which will be spent in bivouac is indicated in ATP 33-300. The field bivouac should be conducted under conditions

approximating actual operations. Particular attention should be given to dispersion, concealment from aerial observation, local security, and chemical, biological, and radiological protective measures. Bivouac areas should be moved frequently to accustom individuals to the rapid displacement required in special forces combat operations.

b. Night training is indicated in ATP 33-300. This stage of training should comprise not less than 33 percent of all tactical training, movements, and operations. During this night training, individual and unit discipline will be stressed.

Section II. TRAINING PHASES

9. Basic Combat Training Phase (Unclassified)

a. Training during this phase will be conducted in accordance with ATP 21-114. This phase will be completed prior to entering advanced individual training.

10. Basic Parachute Training Phase (Unclassified)

Training will be conducted in accordance with ATP 21-114.

11. Advanced Individual Training Phase (Unclassified)

This phase of training consists of—

a. Specialist training, including methods and procedures for training individuals to qualify them for occupational specialties, mobilization requirements, and TOE positions.

b. Branch training as prescribed at ATP 33-300.

12. Unit Training Phase (Unclassified)

Program of instruction for unit training to include scopes of subjects will be found in ATP 33-300.

APPENDIX VI

GUIDE FOR LOGISTICAL SUPPORT

1. General (Confidential)

After operational teams are infiltrated into designated areas on assigned missions, the commander of the joint unconventional warfare task force (JUWTF) or other designated command will assume the responsibility for providing the necessary control of and logistical support for all behind-the-lines activities. Qualified officer personnel and enlisted assistants, directly responsible to J4, will organize and operate each logistical installation.

2. Requirements (Confidential)

In order to provide the necessary logistical support for behind-the-lines activities, the following facilities and installations will be required

- a.* Signal.
- b.* Ordnance.
- c.* Quartermaster.
- d.* Transportation.
- e.* Medical.
- f.* Counterintelligence.
- g.* Military Police.

3. Signal Requirements (Confidential)

a. Radio is the most effective means of communication, because of its extreme flexibility.

Radio can provide a high degree of portability and possesses the long distance capabilities required by guerrilla forces. High powered radio transmitters are employed in a base station to insure efficient communications with operational teams. Such transmitters, and their associated antenna systems, should be located at some distance from the receiving location and remotely controlled from the radio operator's receiving position. Transmitters should be capable of rapid frequency switching from the remote control position. Transmitting and receiving antenna systems for a base station should be of the directional type.

- (1) Base communications facilities require a fixed station type installation. Initial planning for this installation must be predicated on the initial support required in the operational area, and on the continued expansion, of, guerrilla forces with a corresponding increase in required support. This station should be planned and located so as to permit a rapid buildup of facilities and personnel with a minimum of disruption in the efficiency of operations.
- (2) A base station is an integrated fixed station communications center. This installation must have highly trained communication's specialists in the fields of fixed station radio installation and maintenance, radiotelegraph and radio teletype operation, cryptography, message center procedures, and radio and teletype

repair. Signal Corps communications teams are designed to install, operate, and maintain communications and to provide electronic countermeasures, signal intelligence, supply, and maintenance of signal equipment. Computation of types and numbers of teams required will depend on the station facilities employed and the traffic load involved.

b. Additional radio operators and repairmen will be required to maintain test and service communications equipment for operational teams, as well as maintain the JUWTF administrative net.

c. A photographic laboratory will be established. It must be capable of providing instructors, pictorial services, and the supply of photographic materials required by operational teams.

4. Ordnance Requirements (Confidential)

a. U.S. and indigenous personnel must be capable of instructing in small arms repair on U.S. and foreign weapons. They also must be capable of repairing weapons and of inspecting weapons to be packaged for delivery. The quantity of ordnance supply required for guerrilla forces will dictate a need for an advisor in the J4 section.

b. Automotive maintenance technicians will be required to maintain motor transport and labor saving equipment used in operating an installation of this type.

5. Quartermaster Requirements (Unclassified)

a. Warehouses are established for the receipt and storage of standard and nonstandard items of supply until such time as they are packaged for delivery.

b. A packaging facility may be organized into three sections—

- (1) A standard packing section prepares standard items of supply for delivery in self-contained units.
- (2) A special packing section processes nonstandard items of equipment, such as radio accessories and medical supplies, that require special handling.
- (3) A parachute packing section is responsible for packing personnel and cargo parachutes.

c. Storage facilities are required for standard items of supply packed for delivery to the operational areas. These self-contained units will be protected from the weather wherever possible and stored in a manner to permit their handling by efficient laborsaving equipment. Nonstandard items and equipment normally will be packed for immediate delivery to fill a specific requirement.

6. Transportation Requirements (Confidential)

A motor pool facility will be established to provide the transportation required to support operations. Indigenous personnel should be trained and utilized to the maximum extent possible.

7. Medical Requirements (Unclassified)

Special medical supply requirements of the operational teams create a need for specialists to supervise the procurement and packaging of these medical supplies for delivery.

8. Counterintelligence Requirements (Confidential)

a. Skilled and carefully selected counter-intelligence personnel will be required to screen indigenous administrative and operational personnel and to provide security from sabotage, subversion, and espionage.

9. Military Police Requirements (Unclassified)

Traffic control and physical security of these facilities will require military police personnel. Selected civilians may be utilized to augment these personnel.

10. Role of Special Forces Base (Confidential)

The special forces base (ch. 5) when directed and properly augmented is capable of providing, on a temporary basis, the necessary control and logistical support of behind-the-lines activities.

APPENDIX VII

FIELD EXERCISE

1. General (Unclassified)

a. Field exercises are conducted to provide practical instruction for the individual and to enable the commander to determine the state of readiness of his unit. Training exercises should be conducted as realistically as practicable and still insure safety to the personnel. This does not preclude the rigorous implementation of a field problem under adverse weather conditions and in difficult terrain.

b. Field problems for special forces operational teams undergoing training primarily consist of—

- (1) Infiltration.
- (2) Clandestine operations.
- (3) Resupply operations.
- (4) Tactical, operations.
- (5) Command post exercises for the special forces group.

c. Special forces personnel participating in these exercises many times, of necessity, operate in the role of the guerrilla. Security and practicability will determine the use of indigenous personnel in a training role. Special forces personnel are instructed in all phases of these operations to insure that they will understand the capabilities and limitations of guerrilla units in an actual area of operations.

d. All field exercises should be immediately followed by a critique. Deficiencies should be revealed and corrective action determined to insure that desired standards and proper methods will be followed in the unit.

2. Infiltration (Unclassified)

a. Problems in infiltration of operational detachments are based on the mission of special forces operational units. All detachments should be capable of infiltrating into an area of operations by air, sea, or land. All operational units should be able to plan and conduct an infiltration by each of these methods.

b. The air infiltration exercise should include the planning and preparation by the operational team necessary for the air movement to the drop location, the reception on the ground, arrangement for signs and countersigns, rendezvous points, movement to a same area, and finally the establishment of radio contact with the headquarters within friendly lines. The exercise is based on the following phases—

- (1) Planning and preparation.
- (2) Air movement and parachute drop.
- (3) Reception by indigenous personnel.
- (4) Movement to safe area.
- (5) Radio contact.

c. Drop zones utilized should be as small as safety permits. Night parachute drops should be conducted to provide realism and problems in assembly. A problem of this type can be conducted

in 24 to 48 hours. The movement from the drop zone to the safe area can vary from 10 to 25 miles. Aggressor personnel should be used to establish an enemy security force.

d. Sea infiltration problems are conducted in the five phases as given in the air infiltration. The phase of amphibious movement is substituted, for the air movement. Problems in sea infiltration can, be conducted in coastal areas or by utilizing large lakes. When practicable coastal areas should be used for this training. Movement should be made by surface craft or submarine to a point off shore, followed by the movement of the operational teams in shore by the use of small boats. When a lake is the only facility available, movement of the team can be accomplished by the use of small boats moving from a simulated craft off shore. Aggressor, personnel should be employed to present the situation of enemy coastal forces and security forces.

e. The phases for land infiltration in general are the same as for air infiltration. Land infiltration problems again are conducted at night. Aggressor personnel should be used to provide situations in infiltration through an enemy front line position and the movement across the border of a neutral country into an enemy country. Additional personnel should be used to act as an enemy security force. Land infiltration problems should be conducted to provide instruction in movement through the following type areas:

- (1) Mountains.
- (2) Jungles.
- (3) Arctic wastes.
- (4) Swamps.
- (5) Desert.

3. Clandestine Operations (Unclassified)

a. These exercises are conducted to provide a problem in planning, organizing, and operating clandestine nets. When necessary, the exercise can be conducted by using the facilities found on the average military post. If possible a small civilian town and its surrounding rural area should be employed. Situations should be developed to establish problems in the organization of the following type nets

- (1) Intelligence.
- (2) Sabotage.
- (3) Evasion and escape.
- (4) Security.

b. Realistic implementation of this type problem requires detailed planning and arrangements to prepare the facilities used. Civilian administrative organization should be used when practicable to provide the realism necessary for this type field problem. This problem. is conducted in three phases:

- (1) Planning and preparation.
- (2) Organization of net.
- (3) Conduct of operation.

c. The planning and preparation phase encompasses the intelligence and reconnaissance

employed to determine data necessary to organize a clandestine net.

d. During organization phase, the unit contacts and organizes agents, safe houses, and letter drops. When preparing the area for training, selected people who will act as agents should be used to cooperate with the team conducting the exercise, while at the same time, and unknown to the team, they are employed to report information to the local police force. This will serve as a test of the security and compartmentation in the net organization. Team personnel are employed within the net which they have organized. Personnel should be observed throughout the exercise and those making errors are apprehended and put through a realistic interrogation. Security and funds may preclude the use of civilian facilities. In this event, the exercise may be developed and conducted at a military garrison utilizing agencies such as military police and counterintelligence units. When these facilities are not readily available, classroom instruction may be employed by furnishing data for planning and organizing a net in a particular area, and then by presenting situations for solution by the personnel participating in the training.

e. A map exercise of this type should be used to supplement the practical work discussed previously, but should not replace it.

4. Resupply Operations (Unclassified)

a. Field exercises having requirements in resupply operations primarily encompass two situations. One is the reception of resupply by air drop, the other is the reception of resupply by boat. Each of these exercises is conducted in the following phases:

- (1) Planning and preparation for the reception.
- (2) Reception of resupply.
- (3) Movement of supply to safe area.
- (4) Distribution of supplies.

b. A unit conducting the reception of supply by air drop begins by reconnoitering and locating a drop zone. It then is required to send by radio the necessary site data for the air drop. The air drop should be made at night to provide realism in collecting bundles, employment of drop zone security forces and movement of supplies to a safe area. When possible, various means such as pack board, pack animals, wagons, and trucks should be employed in movement of the supplies to provide realistic training in their use. Aggressor forces should be employed to act as enemy security units to test, the planning and organization of the exercise.

c. Reception problems employing the use of resupply by sea are fundamentally the same as reception of supply by air drop. The unit conducting the exercise is required to reconnoiter and determine a reception site. This data should be sent by radio to the headquarters in the rear. The reception exercise should be conducted at night. Small boats should be employed by the team to move supplies from a boat or submarine off shore. Radio communications should be established from the reception point ashore to the ship at sea. Movement of supplies should be conducted by the means discussed in the reception of an air resupply operation (*b* above). When coastal areas are not available for training, the exercise may be conducted on a lake employing

small boats and simulating the surface craft or submarine. Supplies used in both types of reception should be actual weights and volumes.

5. Tactical Operations (Unclassified)

a. Field problems in tactical operations evolve primarily, the following:

- (1) Raid.
- (2) Ambush.
- (3) Harassing activity.
- (4) Defensive operations.
- (5) Limited attacks.

b. Normally the special forces team participating in these training exercises must, of necessity, operate in the capacity of guerrillas. Personnel should be instructed that it is not normal of special forces teams to function in this manner in actual operations. Care should be taken to insure that units do not develop, a "commando"; approach to operations behind the lines. Training in these operations will insure that all special forces personnel understand the methods of guerrilla tactical operations, capabilities, and limitations.

c. Each exercise should be conducted as realistically as practicable. Where possible, live ammunition should be utilized in these problems. Each offensive action is conducted in the following phases:

- (1) Planning and preparation.
- (2) Movement to point of action.
- (3) Conduct of action.
- (4) Withdrawal from action.

d. Teams conducting an exercise should go through each phase to insure complete troop leading procedure. Aggressor personnel should be utilized to provide realism in the target area and to simulate situations of enemy reinforcement and conduct of the withdrawal.

e. Defensive exercises provide instruction in the establishment of strong points and escape from enemy encirclement. Where practical, conventional units should be used to act in the role of an enemy encircling force.

6. Field Exercise, Special Forces Group (Unclassified)

a. Special forces group field exercises entail all the operations that would be considered normal for the tactical employment of operational teams. The group should establish a base with necessary facilities to support the employment of its tactical units, including then establishment of communications to a higher headquarters and to operational teams behind the lines: A briefing and staging-center should be provided.

b. The field exercise normally is conducted in the following phases:

- (1) Planning and preparation.
- (2) Infiltration of operational teams.
- (3) Organization and development of guerrilla forces by the operational teams.
- (4) Conduct of offensive operations behind the lines.
- (5) Conduct of resupply operations.

(6) Conduct of operations in direct support of conventional forces.

(7) Conduct of contact operations with conventional forces.

c. Personnel acting as indigenous forces should be used to provide realism for the operational teams: For planning purposes, nine individuals per team FA should be sufficient to establish situations of the phases in organization and development, reception of resupply, and the conduct of operations.

d. Aggressor forces should be used to establish enemy security forces in a rear area. Care should be taken to insure that these forces do not become overly aggressive and harassing. Operational teams should not be required to move their base, unless they have made mistakes in their operations.

e. A complete communications system should be established between the team FA and the base station.

f. The field exercise written for the special forces group should contain

- (1) Scenario.
- (2) Administrative plan.
- (3) Umpire and control plan.
- (4) Aggressor plan.
- (5) Signal plan.

~~CONFIDENTIAL~~

~~CONFIDENTIAL~~

INDEX

	<i>Paragraph</i>	<i>Page</i>
Adjutant, special forces group	11	12
Administration:		
Guerrilla forces	74-76	70
Special forces group	47-51	45
Facilities, special forces base.....	42	42
Guidance to guerrilla units.....	51	47
Problems of operational teams.....	50	46
Support to committed teams	49	46
Units, group:		
Headquarters and headquarters company	28	28
Quartermaster special forces parachute, rigging detachment	29	31
Team AA	30a	31
Team AB	30b	31
Agent:		
Definition.....	App. II	131
Recruitment.....	App. III	133
Training	App. III	133
Air resupply:		
Operations.....	139-142	123
Requirements	141	125
Ambush	102	93
Columns protected by armor	107	98
Planning	103	94
Position, movement	104	95
Position, selection	106	96
Railroad trains	108	98
Security	105	95
Amphibious resupply operations	135-138	120
Amphibious resupply, requirements	136	121
Attached and supporting units, special forces		
Group	26	26
Attachments, technical and service units	8	10

~~CONFIDENTIAL~~

	<i>Paragraphs</i>	<i>Page</i>
Base, special forces.....	36-46	38
Briefing center	46	43
Briefing, intelligence.....	52	49
Build-up of guerrilla forces.....	72	66
Call signs.....	App. IV	146
Caches and storage	119	107
Cell, definition.....	App. II	131
Chaplain, group	22	23
Characteristics of special forces group.....	4	6
Civilian first-aid units	123	109
Civilian medical facilities.....	121	108
Clandestine intelligence	App. III	133
Clandestine net.....	App. II, III	131, 133
Collection of information, guerrilla	81	75
Commanding officer, operational detachment, Area.....	16	18
Command medical officer, group	23	24
Command structure, special forces base	40	41
Commitment of teams, group adjustment.....	48	45
Committed teams, administrative support	49	46
Communications:		
Guerrilla force.....	127-134	113
Net, organization	App. IV	146
Officer, group.....	17	18
Personnel for guerrilla force.....	130	114
Plans for guerrilla force	129	113
Radio	134	117
Responsibility for guerrilla force	128	113
Special forces.....	62-65	55
Training	64	56
Training requirements	App. IV	146
Composition, group	7	9
Counterintelligence:		
Guerrilla.....	83,84	79
Requirements	App. VI	160
Cover story, definition	App. II	131
Cryptographic systems	App. IV	146

	<i>Paragraphs</i>	<i>Page</i>
Defense against encirclement.....	122	109
Defense of fixed positions.....	111	99
Defensive operations, guerrilla.....	110-112	99
Definitions.....	App. II	131
Dispersion, guerrilla.....	91	87
Dispositions, guerrilla.....	93	88
Drop and landing zones, selection.....	140	124
Encirclement, defense.....	112	100
Enemy operations, guerrilla reaction.....	95	89
Equipment, radio.....	App. IV	146
Equipment, reception committee.....	142	125
Estimate of the training situation.....	59	53
Evaluation of guerrilla capabilities.....	61	54
Evasion and escape, definition.....	App. II	131
Exercise, field.....	App. VII	165
Exploitation of guerrilla forces.....	73	68
Facilities, civilian medical.....	121	108
Field exercise.....	App. VII	165
First aid units, civilian.....	123	109
Fixed positions, defense.....	111	99
Food advisor, group.....	19	21
Frequencies and call signs.....	App. IV	146
Functions, special forces base.....	42-46	42
Glossary.....	App. II	131
Group chaplain.....	22	23
Guerrilla:		
Capabilities, evaluation.....	61	54
Counterintelligence.....	83, 84	79
Defensive operations.....	110-112	99
Dispositions.....	93	88
Hospitals.....	126	110
Intelligence agencies.....	App. III	133
Intelligence organization.....	79	72
Intelligence requirements.....	80	73
Marches.....	89	86
Medical service.....	120-126	107

~~CONFIDENTIAL~~

	<i>Paragraphs</i>	<i>Page</i>
Guerrilla—Continued		
Medical unit.....	125	110
Mobility 92 88		
Security measures	90,95	86
Signal staff section	131	115
Units, administrative guidance.....	51	47
Guerrilla force:		
Administration	74-76	70
Buildup	72	66
Communications.....	127-134	113
Exploitation	73	68
Intelligence	77-84	72
Intelligence organization, mission.....	78	72
Logistics	113-126	103
Operations.....	85-112	83
Organization.....	71	63
Supply.....	113-119	103
Training.....	86	84
Guerrilla warfare, definition	App. II	131
Guide for logistical support	App. VI	160
Harassing activity	109	98
Headquarters commandant, group	18	20
Headquarters and headquarters company.....	28, 48a	28, 45
Hospitals, guerrilla.....	126	110
Infiltration of special forces teams	70	63
Intelligence:		
Agencies, guerrilla.....	App. II	131
Clandestine.....	App. III	133
Guerrilla force	77-84	72
Officer, special forces group	12	13
Planning and organization.....	54	50
Special forces.....	52-54	49
Joint:		
Sector force.....	4b	6
Sector staff	App. II	131
Unconventional warfare task force.....	4, 6, 36, 46; App. II	6, 9, 38, 43, 131

	<i>Paragraphs</i>	<i>Page</i>
Landing zones, selection.....	140	124
Levy system of supply procurement.....	117	106
Location, special forces base	7, 38	38
Logistical facilities, special forces base	43	42
Logistics, guerrilla force	113-126	103
Marches and movement, guerrilla force	87-89	85
Medical:		
Facilities, civilian	121	108
Officer, group	23	24
Personnel.....	122	109
Requirements	App. VI	160
Service, guerrilla.....	120-126	107
Supply.....	124	109
Unit, guerrilla	125	110
Messenger service	133	116
Military police requirements	App. VI	160
Mission, special forces base.....	37	38
Mission, special forces group.....	5	6
Mobility, guerrilla.....	92	88
Motor officer, group	20	21
Movement to ambush position.....	104	95
Munitions officer, group	25	26
Net		
Administrative	64a	56
Clandestine.....	App. II, 111	131, 133
Command	64b	56
Communications.....	App. III	133
Guerrilla.....	64d	56
Guerrilla security	94	88
Operational	64c	56
Radio	64	56
Security	App. III	133
Offensive operations, guerrilla.....	96-109	89
Operational detachment:		
Area (team FD).....	35	37
District A (team FC).....	34	37

~~CONFIDENTIAL~~

	<i>Paragraphs</i>	<i>Page</i>
Operational detachment—Continued		
District B (team FB)	33	35
Regimental (team FA)	32	35
Operational responsibility, joint unconventional warfare task force.....	6	9
Operational teams:		
FA.....	32	35
FB	33	35
FC	34	37
FD	35	37
Administrative problems	50	46
Infiltration	70	63
Operations and training officer, group	13	14
Operations:		
After commitment	66-74	58
Guerrilla defensive.....	110-112	99
Guerrilla force.....	85-112	83
Guerrilla offensive.....	96-109	89
Psychological warfare	68	59
Resupply.....	135-142	120
Ordnance requirements	App. VI	160
Organization and training, guerrilla force	85, 86	83, 84
Organization:		
Guerrilla:		
Forces.....	71	63
Intelligence	79	72
Supply.....	115	105
Special forces base.....	39	39
Training, group	56	52
Parachute maintenance officer, group	24	25
Payment of supplies, receipt system.....	116	105
Personnel, medical	122	109
Personnel officer, group.....	21	22
Phases of guerrilla force development:		
I—psychological preparation	68	59
II—initial contact with resistance forces	69	61
III—infiltration of operational teams	70	63
IV—organization.....	71	63

	<i>Paragraphs</i>	<i>Page</i>
Phases of guerilla force development—Con.		
V—build-up	72	66
VI—exploitation.....	73	68
VII—administration.....	74	70
Planning:		
Ambush	103	94
Guerrilla training	60	54
Raid.....	99	91
Signal	App. IV	146
Plans for guerrilla force communications.....	129	110
Plans for resupply reception.....	137	122
Preparation for march, guerrilla	88	85
Psychological warfare operations	68	59
Quartermaster requirements	App. VI	160
Quartermaster special forces parachute rigg ing detachment.....	29, 48a	31, 45
Radio:		
Communications.....	134	117
Equipment	App. IV	146
Nets	64	56
Raids, planning and conduct.....	97-101	90
Railroad trains, ambush.....	108	98
Receipt system for payment of supplies.....	116	105
Reception committee equipment, resupply.....	142	125
Reception operations, conduct	138	123
Reconnaissance	98, App. III	91, 133
Recruitment, agent	App. III	133
References,	App. I	127
Requirements		
Communications training.....	App. IV	146
Counterintelligence.....	App. VI	160
Intelligence	80	73
Medicals	App. VI	160
Military police	App. VI	160
Ordnance.....	App. VI	160
Quartermaster	App. VI	160
Signal	App: VI	160

~~CONFIDENTIAL~~

Requirements —Continued	<i>Paragraphs</i>	<i>Page</i>
Special forces intelligence.....	53	49
Transportation	App. VI	160
Resistance, definition	App. II	131
Resistance forces, initial contact.....	69	61
Responsibility for guerrilla:		
Administration	75	71
Communications.....	128	113
Security	90	86
Supply.....	114	104
Training.....	58-61	53
Resupply operations.....	135-142	120
Security measures, guerrilla.....	90-95	86
Security, net	App. III	133
Security nets, guerrilla.....	94	88
Security of information, guerrilla.....	84	79
Selection of ambush position.....	166	96
Selection of drop and landing zones.....	140	124
Signal:		
Officer, group.....	63	55
Operation instructions	App. IV	136
Planning	App. IV	136
Requirements	App. VI	160
Section, group	63	55
Staff section, guerrilla.....	131	115
Sources of guerrilla supply, other	118	106
Special forces base.....	36-46	38
Special forces group:		
Characteristics.....	4	6
Composition.....	7, 27-35	9, 28
Mission.....	5	6
Special staff	15-26	17
Unit staff	9-14	11
Special forces intelligence.....	52-54	49
Special staff, group:		
Command medical officer.....	23	24
Commanding officer, operational de- tachment, area.....	16	18

	<i>Paragraphs</i>	<i>Page</i>
Special staff, group—Continued		
Communications officer	17	18
Food advisor	19	21
Group chaplain	22	23
Headquarters commandant	18	20
Motor officer	20	21
Munitions officer.....	25	26
Parachute maintenance officer	24	25
Personnel officer	21	22
Staff structure, special forces base.....	41	41
Staging and briefing center.....	46	43
Storage and caches	119	107
Supply:		
Guerrilla force.....	113-119	103
Medical.....	124	109
Officer, group.....	14	16
Other sources of guerrilla.....	118	106
Procurement, levy system.....	117	106
Responsibilities for guerrilla.....	114	104
Supporting and attached units, group	26	26
Teams, special forces group:		
AA	30a,48a	31,45
AB.....	30b,48a	31,45
FA.....	32	35
FB	33	35
FC	34	37
FD	35	37
Technical and service unit attachments, group	8	10
Technical services, special forces base.....	44	43
Theater guidance for guerrilla administration	76	71
Training:		
Agent	App. 111	133
Communications.....	65	56
Conduct of group	57	52
Estimate of the situation	59	53
Facilities, special forces base.....	45	43

	<i>Paragraphs</i>	<i>Page</i>
Training—Continued		
Group organization	56	52
Guerrilla force.....	86	84
Training:		
Guide.....	App. V	155
Objectives.....	App. V	155
Transportation requirements	App: VI	160
Unconventional warfare, definition	App. II	131
Unit staff, group:		
Executive officer.....	10	11
S1.....	11	12
S2.....	12	13
S3.....	13	14
S4.....	14	16

~~CONFIDENTIAL~~

BY ORDER OF THE SECRETARY OF THE ARMY:

MAXWELL D. TAYLOR,
General, United States Army,
Chief of Staff.

OFFICIAL:

JOHN A. KLEIN,
Major General, United States Army,
The Adjutant General.

DISTRIBUTION:

Active Army:

Gen Staff, DA (25)
Tec Svc, DA (1)
Adm & Tec Svc Bd (1)
Hq, CONARC (40)
OS Maj Comd (5)
OS Base Comd (1)
Log Comd (1)
Armies (2)
MDW (1)
Corps (2)
Div (2)
USMA (2)
Gen & Br Svc Sch (5)

Units organized under following TOE's:

10-419, QM Sp Forces Prcht Rigging Det (2)
33-2, Hq & Hq Co, Sp Forces Gp, Abn (10)
33-510, (AA-AB), Sp Forces Org (5)

NG: Div (2).

USAR: Div (2).

For explanation of abbreviations used, see SR 320-50-1.

~~CONFIDENTIAL~~

~~CONFIDENTIAL~~

~~CONFIDENTIAL~~

~~CONFIDENTIAL~~

~~CONFIDENTIAL~~

~~CONFIDENTIAL~~

~~CONFIDENTIAL~~

~~CONFIDENTIAL~~

~~CONFIDENTIAL~~

WARNING NOTICES

Authority for release of this document to a foreign government must be secured from the Assistant Chief of Staff, G—2, Department of the Army.

When this document is released to a foreign government, it is released subject to the following conditions: This information is furnished with the understanding that it will not be released to another nation without specific approval of the United States of America, Department of the Army; that it will not be used for other than military purposes; that individual or corporation rights originating in the information whether patented or not will be respected; and that the information will be afforded substantially the same degree of security as afforded by the United States of America, Department of the Army.

This document contains information affecting the national defense of the United States within the meaning of the Espionage Laws, Title 18, U.S.C., sections 793 and 794. The transmission or the revelation of its contents in any manner to an unauthorized person is prohibited by law.

Classified by DA
Subject to GDS of EO 11652
Automatically Downgrade at Two
Year Intervals
Declassified on May 3, 1976.